

# Documentation

## OpenScope Voice

OpenStage 40 SIP, OpenStage 40 G SIP

OpenStage Key Module 40

## User Guide





Communication for the open minded



Siemens Enterprise Communications  
[www.siemens.com/open](http://www.siemens.com/open)

**SIEMENS**

## Important information

	<p>For safety reasons, the telephone should only be supplied with power:</p> <ul style="list-style-type: none"><li>• using the original power supply unit. Part number: L30250-F600-C14x (x: 1=EU, 2=US, 3=UK) or</li><li>• in a LAN with PoE (Power over Ethernet), which complies with the IEEE 802.3af standard.</li></ul>
	<p>Use only original Siemens accessories. The use of other accessories may be hazardous and will render the warranty and the CE marking invalid.</p>
	<p>Never open the telephone or a key module. Should you encounter any problems, contact your administrator.</p>

## Trademarks

	<p>The device conforms to the EU directive 1999/5/EC as attested by the CE marking.</p>
	<p>All electrical and electronic products should be disposed of separately from the municipal waste stream via designated collection facilities appointed by the government or the local authorities.</p> <p>Proper disposal and separate collection of your old appliance will help prevent potential damage to the environment and human health. It is a prerequisite for reuse and recycling of used electrical and electronic equipment.</p> <p>For more detailed information about disposal of your old appliance, please contact your city office, waste disposal service, the shop where you purchased the product or your sales representative.</p> <p>The statements quoted above are only fully valid for equipment which is installed and sold in the countries of the European Union and is covered by the directive 2002/96/EC. Countries outside the European Union may impose other regulations regarding the disposal of electrical and electronic equipment.</p>

## Location of the telephone

- The telephone should be operated in a controlled environment with an ambient temperature between 5°C and 40°C.
- To ensure good speakerphone quality, the area in front of the microphone (front right) should be kept clear. The optimum speakerphone distance is 50 cm.
- Do not install the telephone in a room where large quantities of dust accumulate; this can considerably reduce the service life of the telephone.
- Do not expose the telephone to direct sunlight or any other source of heat, as this is liable to damage the electronic components and the plastic casing.
- Do not operate the telephone in damp environments such as bathrooms.

## Product support on the internet

Information and support for our products can be found on the Internet at: <http://www.siemens-enterprise.com/>.

Technical notes, current information about firmware updates, frequently asked questions and lots more can be found on the Internet at: <http://wiki.siemens-enterprise.com/>.

# Contents

## Important information .....2

Trademarks .....	2
Location of the telephone .....	3
Product support on the internet .....	3

## General information.....11

About this manual .....	11
Symbols used in the manual .....	11
Service.....	12
Intended use .....	12
Telephone type .....	12
Speakerphone quality and display legibility .....	12
Single-line telephone/multi-line telephone.....	13

## Getting to know your OpenStage phone .....14

The user interface of your OpenStage 40/40 G.....	14
Ports on the underside of the phone.....	15
Using network ports more efficiently .....	16
Key Module .....	17
OpenStage Key Module 40 .....	17
OpenStage Key Module 15 .....	18
Keys.....	19
Function keys.....	19
Audio keys.....	19
Navigator .....	20
Programmable sensor keys .....	21
Trunk keys (on multi-line phones only).....	22
Keypad .....	24
Display.....	26
Idle mode.....	26
Idle-display view and icons .....	26
Context-dependent displays .....	27
Telephony interface.....	29
Single-line view .....	29
Multi-line view .....	30
Phonebooks.....	32
Personal phonebook .....	32
LDAP directory.....	33
Messages .....	34
Voicemail .....	34
Calls .....	35

Telephone menu . . . . .	37
Program/Service menu . . . . .	37
User settings . . . . .	37
Administration . . . . .	38
Control and monitoring function . . . . .	38

## **Basic functions . . . . . 39**

Secure voice transmission . . . . .	39
Answering a call . . . . .	39
Answering a call via the handset . . . . .	40
Answering a call via the loudspeaker (speakerphone mode) . . . . .	40
Accepting a call via the headset . . . . .	41
Directed pickup . . . . .	42
Picking up call . . . . .	42
Picking up the held call: . . . . .	43
Switching from handset to speakerphone mode . . . . .	44
Switching from speakerphone mode to the handset . . . . .	44
Switching from headset to speakerphone mode . . . . .	45
In standard mode . . . . .	45
In U.S. mode . . . . .	45
Open listening . . . . .	45
Activating/deactivating the microphone . . . . .	46
Ending a call . . . . .	46
Group call . . . . .	47
Making calls . . . . .	49
Off-hook dialing . . . . .	49
On-hook dialing . . . . .	50
Immediate dialing . . . . .	51
Dialing using the hot or warm line function . . . . .	52
Redial . . . . .	53
Consulting a second party . . . . .	54
Switching to the held party (alternating) . . . . .	55
Putting on hold and retrieving successively or simultaneously . . . . .	56
Connecting parties . . . . .	57
Call forwarding . . . . .	58
Programming call forwarding . . . . .	59
Activating/deactivating call forwarding . . . . .	61
Activating call forwarding for all calls . . . . .	62
Call forwarding chain . . . . .	63
Callback . . . . .	64
Requesting callback . . . . .	64
Responding to a callback . . . . .	65
Permitting callback on busy/no reply . . . . .	66
Calling back missed calls . . . . .	67

<b>Programmable sensor keys</b> .....	<b>68</b>
List of available functions .....	68
Programming sensor keys .....	69
Beginning programming .....	69
Beginning programming .....	70
Programming enhanced functions .....	70
Repertory dial .....	70
Feature toggle .....	72
Forwarding .....	73
Using sensor keys .....	74
Example 1: Calling saved number .....	74
Example 2: Call Waiting toggle Activating/deactivating .....	74
Example 3: Immediate ring .....	74
Resetting sensor keys .....	75
<b>Enhanced phone functions</b> .....	<b>76</b>
Incoming calls .....	76
Accepting calls via the headset .....	76
Deflecting a call .....	76
Rejecting a call .....	78
Configuring call forwarding .....	78
Placing a call on hold .....	80
Call waiting (second call) .....	83
Transferring a call .....	87
CTI calls .....	90
Making calls .....	92
Dialing with the DDS key .....	92
Dialing from the local phonebook .....	92
Dialing from the LDAP database .....	92
Dialing a phone number from a list .....	93
Using autodial delay .....	94
Conference .....	97
Local conference .....	97
System-based conference .....	100
<b>Phonebooks and call lists</b> .....	<b>102</b>
Local phonebook .....	102
Creating a new contact .....	102
Editing a contact .....	102
Deleting a contact .....	103
Deleting all contacts .....	103
Searching for a contact .....	104

LDAP database . . . . .	105
Finding an LDAP entry . . . . .	105
Extended LDAP editing . . . . .	106
Quick search . . . . .	107
Call lists . . . . .	108
Editing entries . . . . .	108
Deleting all entries . . . . .	108
<b>Making calls with multiple lines . . . . .</b>	<b>109</b>
Incoming calls . . . . .	109
Accepting calls for the primary line . . . . .	109
Accepting calls for secondary lines . . . . .	109
Making calls . . . . .	110
Manual trunk seizure . . . . .	110
Automatic trunk seizure . . . . .	111
Dialing the last dialed number . . . . .	111
Forwarding calls on primary line . . . . .	111
During calls . . . . .	112
Making and receiving calls on a single line . . . . .	112
Making and receiving calls with multiple lines . . . . .	112
Putting a line on hold . . . . .	113
Lines with hot or warm line function . . . . .	114
Busy override . . . . .	115
Direct station selection keys . . . . .	116
Calling a station directly . . . . .	116
Call pickup . . . . .	117
Deflecting a call to a DSS station . . . . .	118
LED display on DSS keys . . . . .	118
Making calls in an executive-secretary team . . . . .	119
Sample scenarios . . . . .	119
Accepting a call . . . . .	120
Connecting a call . . . . .	121
DSS keys can be used . . . . .	123
Using line overview . . . . .	123
Settings for multi-line phones (keyset) . . . . .	124
Displaying the line in the "Overview" tab . . . . .	124
Setting the time for a delayed ringer . . . . .	125
Configuring the "Overview" tab display . . . . .	126
Line preview . . . . .	127
Rollover for a line . . . . .	128

<b>Privacy/security</b> .....	<b>129</b>
Deactivating the ringer .....	129
Do not disturb .....	130
Enabling "Do not disturb" via a key .....	130
Enabling "Do not disturb" via the idle menu .....	130
Allowing "Do not disturb" .....	131
Security .....	132
User password .....	132
Locking the phone .....	134
<b>Mobility</b> .....	<b>136</b>
Mobility scenarios .....	136
Logging on and off at the same phone .....	136
Logging on and off at different phones .....	136
Logging on and off at the same phone .....	137
Logging on to the phone .....	137
Logging off from the phone .....	138
Logging on at different telephones .....	139
Logging on with forced logoff at a remote phone .....	139
Logging on with forced, delayed logoff at a remote phone .....	140
<b>OpenScope Voice functions</b> .....	<b>141</b>
Feature toggle key .....	141
Making anonymous calls .....	142
Deactivating .....	142
Activating .....	142
Temporarily activating anonymous calling for the next call .....	143
Temporarily deactivating anonymous calling for the next call .....	143
Creating a list for selective calls .....	144
For call acceptance .....	144
For call rejection .....	145
Anonymous calls .....	146
Rejecting .....	146
Accepting .....	146
Using abbreviated dialing .....	147
Call tracing .....	147
Hunt group functions .....	148
Making a line busy .....	148
Marking the last line in the hunt group chain .....	149
Reachability .....	150
Serial call .....	150
Parallel call .....	151
Parking a call .....	153
Park a call .....	153
Unparking .....	153



Silent Monitoring . . . . .	154
Active silent monitoring . . . . .	154
Muted silent monitoring . . . . .	155
Table of codes for OpenScape Voice functions. . . . .	156

## **Individual phone configuration . . . . . 157**

Display . . . . .	157
Adjusting the display to a comfortable reading angle . . . . .	157
Setting contrast . . . . .	157
Background lighting . . . . .	157
Contrast for the OpenStage Key Module. . . . .	158
Date and time . . . . .	159
Setting the time . . . . .	159
Setting the date . . . . .	159
Setting daylight saving time. . . . .	160
Automatic daylight saving time . . . . .	161
Time display format . . . . .	162
Date display format . . . . .	162
Audio . . . . .	163
Volumes . . . . .	163
Settings . . . . .	164
Nonsecure voice communication tone and message . . . . .	169
Setting the language and country . . . . .	170
Selecting a language . . . . .	170
Country-specific setting . . . . .	172
Context menu . . . . .	173
Activating/deactivating automatic menu display . . . . .	173
Setting the display time . . . . .	173
Network information . . . . .	174
Resetting user data . . . . .	175
Initiating the reset . . . . .	175

## **Web interface (WBM). . . . . 176**

General . . . . .	176
Calling up the Web interface . . . . .	176
Administrator Pages. . . . .	176
User pages. . . . .	177
User menu . . . . .	178

## **Fixing problems . . . . . 181**

Caring for your telephone . . . . .	181
Troubleshooting. . . . .	181
Contact partner in the case of problems . . . . .	182
Labeling keys. . . . .	182

<b>Local user menu .....</b>	<b>183</b>
Opening the user menu on the phone .....	183
User menu display .....	183
Key functions .....	191
 <b>Index .....</b>	 <b>193</b>

# General information

## About this manual

This document contains general descriptions of the technical options, which may not always be available in individual cases. The respective features must therefore be individually defined in the terms of the contract.

If a particular function on your phone is not available to you, this may be due to one of the following reasons:

- The function is not configured for you or your telephone. Please contact your system support representative.
- Your communications platform does not feature this function. Please contact your Siemens sales partner for information on how to upgrade.

This user guide is intended to help you familiarize yourself with OpenStage and all of its functions. It contains important information on the safe and proper operation of your OpenStage phone. These instructions should be strictly complied with to avoid operating errors and ensure optimum use of your multifunctional telephone in the network.

These instructions should be read and followed by every person installing, operating or programming an OpenStage phone.



For your own protection, please read the section dealing with safety in detail. Follow the safety instructions carefully in order to avoid endangering yourself or other persons and to prevent damage to the unit.

This user guide is designed to be simple and easy to understand, providing clear step-by-step instructions for operating your OpenStage phone.

Administrative tasks are dealt with in a separate manual. The Quick Reference Guide contains quick and reliable explanations of frequently used functions.

## Symbols used in the manual

Operations and settings that can be made both at the phone and over the Web interface are indicated by an icon and page reference.



is a reference to an operation or setting performed directly on the phone



is a reference to an operation or setting performed via the Web interface

## Service



The Siemens service department can only help you if you experience problems or defects with the phone. Should you have any questions regarding operation, your specialist retailer or network administrator will gladly help you. For queries regarding connection of the telephone, please contact your network provider.

If you experience problems or defects with the phone, please dial the service number for your country.

## Intended use

The OpenStage phone is a desktop unit designed for voice transmission and for connection to the LAN. It can also be used as a workstation device. Any other use is regarded as unauthorized.

## Telephone type

The identification details (exact product designation and serial number) of your telephone can be found on the nameplate on the underside of the base unit. Specific details concerning your communications platform can be obtained from your service technician.

Please have this information ready when you contact our service department regarding faults or problems with the product.

## Speakerphone quality and display legibility

- To ensure good speakerphone quality, the area in front of the telephone (front right) should be kept clear.  
The optimum handsfree distance is 20 in. (50 cm).
- Proceed as follows to optimize display legibility:
  - Turn the phone to tilt the display. This ensures you have a frontal view of the display while eliminating light reflexes.
  - Adjust the contrast as required → page 157.

## Single-line telephone/multi-line telephone

Your OpenStage 40/40 G is a "multi-line telephone". This means that multiple lines can be configured, which is not the case with single-line phones. Each line is assigned an individual phone number which you can use to make and receive calls.

The programmable sensor keys function as line keys on multi-line phones → page 22.

The "Overview" tab on the telephony interface provides information about the lines configured on your phone and the current status of each line → page 30.

A number of specific features must be considered when using a multi-line phone to make and receive calls → page 109.

## Getting to know your OpenStage phone

The following sections describe the most frequently used operating elements and the displays on your OpenStage phone.

### The user interface of your OpenStage 40/40 G



1	You can make and receive calls as normal using the <b>handset</b> .
2	The <b>graphic display</b> permits intuitive operation of the phone → page 26.
3	You can customize your telephone by assigning phone numbers and functions to the <b>programmable sensor keys</b> → page 26.
4	You can use <b>function keys</b> when conducting a call to access frequently used functions (such as, Disconnect) or to open the Program/Service menu and mailbox → page 19.
5	<b>Audio keys</b> are also available, allowing you to optimally configure the audio features on your telephone → page 19.
6	The <b>5-way navigator</b> is a convenient navigation tool → page 20.
7	The <b>keypad</b> can be used to enter phone numbers and text → page 24.
8	Incoming calls are visually signaled via the <b>call display</b> .

## Ports on the underside of the phone

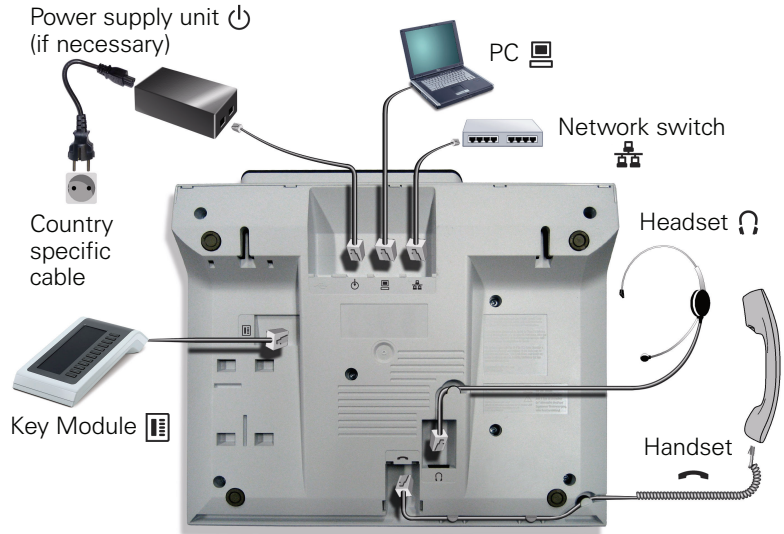

### Properties of your OpenStage 40/40 G

	OpenStage 40	40 G
LCD display, 40 x 6 characters	✓	✓
Illuminated display	✓	✓
Programmable sensor keys	6	6
Full-duplex speakerphone function	✓	✓
Headset	✓	✓
10/100 Mbps Ethernet switch → page 16	✓	-
1000 Mbps Ethernet switch → page 16	-	✓
Interface for key modules	✓	✓
Wall mounting	✓	✓

### Using network ports more efficiently

OpenStage 40 has a built-in 10/100 Mbps Ethernet switch. OpenStage 40 G has a 1000 Mbps Ethernet switch. This means that you can connect a PC to the LAN directly via the phone. The telephone-PC connection option must first be activated on the telephone by service personnel.



Using this connection option saves one network port for each switch used and requires fewer or shorter network cables when arranged correctly.



## Key Module

### OpenStage Key Module 40

The OpenStage Key Module 40 is a key module attached to the side of the phone that provides 12 additional illuminated, programmed keys. Like keys on the phone, these keys can be programmed and used according to your needs → page 21.



You can attach up to two OpenStage Key Module 40s to your OpenStage 40.



To operate an OpenStage Key Module 40 you always require a power supply unit → page 2.

---

## OpenStage Key Module 15

The OpenStage Key Module 15 is a key module attached to the side of the phone that provides an additional 18 illuminated, programmable sensor keys.

Like keys on the phone, these keys can be programmed and used according to your needs. Labeling keys see → page 182.

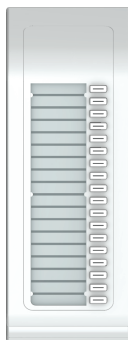





You can only attach one OpenStage Key Module 15 to your OpenStage 40. You **cannot** combine the OpenStage Key Module 15 with the OpenStage Key Module 40.

## Keys





### Function keys

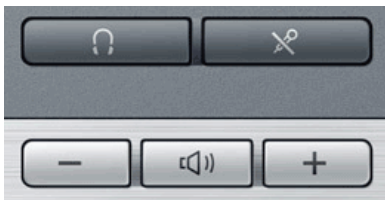

Key	Function when key is pressed	LED display
	End (disconnect) call.	none
	Open redial list	none
	Activate/deactivate forwarding	Red: Call forwarding is activated
	Open phone menu → page 37.	Red: Menu is active
	View messages → page 34.	Red: New voicemail or missed calls.

### Audio keys













Key	Function when key is pressed
	Activate/deactivate microphone (also for speakerphone mode)
	Activate/deactivate the headset.
	Decrease the ring, handset, and loudspeaker volume.
	Activate/deactivate loudspeaker for speakerphone mode and open listening
	Increase the ring, handset, and loudspeaker volume.

## Navigator

 Before using the telephone, remove the protective covering from the navigator surface.

With this control, you can manage most of your phone's functions, as well as its displays.

Operation	Functions when key is pressed
 <p>Press the  key.</p>	<ul style="list-style-type: none"> <li>• Call up the context menu</li> <li>• Perform action</li> <li>• Go down a level</li> <li>• Call up the context menu in the idle display</li> </ul>
 <p>Press the  key.</p>	<ul style="list-style-type: none"> <li>• Short press: One level back</li> <li>• Long press (held down): Go back to the first level of the settings menu</li> <li>• Cancel function</li> <li>• Quit the context menu</li> <li>• In input fields: Delete character to the left of the cursor</li> <li>• <b>Im Ruhemenü Leitungsübersicht aufrufen</b></li> </ul>
 <p>Press the  key.</p>	<ul style="list-style-type: none"> <li>• Scroll downwards</li> <li>• Select element below</li> <li>• Long press (held down): Jump to the end of the list/menu</li> </ul>
 <p>Press the  key.</p>	<ul style="list-style-type: none"> <li>• Scroll upwards</li> <li>• Select element above</li> <li>• Long press (held down): Jump to the start of the list/menu</li> </ul>
 <p>Press the  key.</p>	<ul style="list-style-type: none"> <li>• Confirm input</li> <li>• Perform action</li> <li>• Call up the context menu</li> </ul>

## Programmable sensor keys

Your OpenStage 40 telephone features six programmable lit sensor keys.

 Increase the number of programmable sensor keys by connecting a key module → page 17.

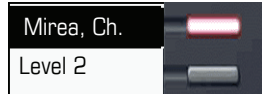

Touch the key briefly to activate the programmed function or dial the stored number → page 74.

If you hold the key pressed, you are prompted as to whether to start programming this function key.

 If the prompt is not displayed or a programmed function is not executed, then you can only launch key programming via the user menu → page 69 (ask your service personnel about the current setting).

 Only for redial keys can you also program the second level for direct destination selection.



You can label these keys with internal and external phone numbers or frequently used functions (platform-dependent; please contact the responsible service personnel).

The configured phone number or function name is displayed next to the key.

The status of a function is shown by the LED on the corresponding sensor key.

 Line and DDS keys can only be programmed by service personnel via the service menu.

### Meaning of LED displays on function keys

LED	Meaning of function key
 Off	The function is deactivated.
 Flashing <sup>1</sup>	Indicates the function status.
 On	The function is activated.

[1] In this manual, flashing sensor keys are identified by this icon, regardless of the flashing interval. The flashing interval represents different statuses, which are described in detail in the corresponding sections of the manual.

### Trunk keys (on multi-line phones only)

The programmable sensor keys on multi-line phones function as trunk keys. Each key programmed with the "Line" function is handled as a line. This means up to five lines can be configured.

A distinction is drawn here between primary, secondary and phantom lines. Each of these line types can be used on a private or shared basis → page 22.

#### Primary line

All multi-line telephones have a primary line. This line can be reached in the usual manner via your public phone number. Incoming calls are signaled on this line.



To avoid conflict between individual multi-line phones, the functions "Do not disturb" and "Call forwarding" can only be used for the primary line.

---

#### Secondary line

The secondary line on your phone is used as a primary line by another subscriber of the line trunk group. Your primary line, which is configured on another telephone in the line trunk group, simultaneously functions as the secondary line on that telephone.

#### Phantom line



Phantom lines are not used as primary lines by any telephones in the line trunk group. Phantom lines are established when the number of lines provided by a communications system exceeds the number of available telephones.

#### Line utilization

- **Private line:** A line that is used by a single telephone. This line cannot be used as a secondary line by another telephone.
- **Shared line:** A line that is configured on multiple telephones. The line status (if configured) is displayed in the "Overview" tab for all telephones that share this line. If, for example, a shared line is being used by a telephone, a status message indicating that this line is busy is displayed on all other telephones.
- **Direct call line:** A line with a direct connection to another telephone.

The line status is indicated by the LED in addition to the display in the "Overview" tab → page 30.

## LED display

LED		Explanation
	<b>Not lit</b>	The phone is in idle mode.
	<b>Flashing</b>	<ul style="list-style-type: none"> <li>Incoming call on the line (→ page 109)</li> <li>"Hold reminder" is activated (→ page 81)</li> </ul>
	<b>Flickering</b>	<ul style="list-style-type: none"> <li>Outgoing call on the line</li> <li>The incoming call was prioritized and selected in accordance with the "Automatic line selection for incoming calls" option</li> </ul>
	<b>Fast blinking</b>	The line is on "Hold".
	<b>Blinking</b>	Call forwarding is activated
	<b>Illuminated</b>	The line is busy

## Keypad

You can only use the digits 1 to 9 and 0 as well as the \* and # characters when dialing a number. The  navigation key is used to delete from right to left.

In cases where text input is possible, you can use the keypad to input text, punctuation and special characters in addition to the digits 0 to 9 and the hash and asterisk symbols. To do this, press the numerical keys repeatedly.



Example: To enter the letter "h", press the number  key on the keypad twice. When entering the text, all available characters for this key are displayed. After a short while, the character in focus is displayed in the input field.



To speed up the input, you can confirm your entry by pressing "" on the navigator after you have selected the required character.

To **enter a digit** in an alphanumeric input field, press the relevant key and hold it down. You no longer need to scroll through the entire list of possible characters.

### Character overview (depends on the current language setting)

Key	1x	2x	3x	4x	5x	6x
	]	1				
	a	b	c	2	ä	
	d	e	f	3		
	g	h	i	4		
	j	k	l	5		
	m	n	o	6	ö	
	p	q	r	s	7	ß
	t	u	v	8	ü	
	w	x	y	z	9	
	0					
	[1]	[2]				



[1] Next letter in upper case (active for maximum one second)

[2] Switch to digit input

	.	,	?	!	'	"	-	(	)	@	/	:	_						
---	---	---	---	---	---	---	---	---	---	---	---	---	---	--	--	--	--	--	--



## Multi-function keys

Key	Function during text input	Function when held down
	Write special characters	Deactivate the ring tone
	Switch between upper and lower case	Activate the telephone lock.

Alphabetic labeling of dial keys is also useful when entering vanity numbers (letters associated with the phone number's digits as indicated on the telephone spell a name, e.g. 0700 - PATTERN = 0700 - 7288376).

## Text editor

A function menu appears under the character selection field in certain situations (such as, when labeling programmable sensor keys). You can enter punctuation marks and special characters and switch between the entry of alphanumeric characters in lower and upper case and straightforward digit entry.

You can select further editor functions via the **click wheel**:

- OK – Confirm and terminate the entire input
- Cancel – Cancel your entries without saving
- Mode Configuration via the key 
  - 123 (# -> ABC) – Numerical entry
  - ABC (# -> Abc) – Upper-case characters
  - Abc (# -> abc) – Initial character upper case
  - abc (# -> 123) – Lower-case characters
- Move cursor left to add or delete characters
- Move cursor right to add or delete characters
- Copy – Copy a visible character string
- Paste – Insert a copied a character string at a cursor position

## Display

Your OpenStage 40 comes with a tilt-and-swivel black-and-white LCD display. Adjust the tilt and contrast to suit your needs (→ page 157).

### Idle mode

If there are no calls taking place or settings being made, your OpenStage 40 is in idle mode.

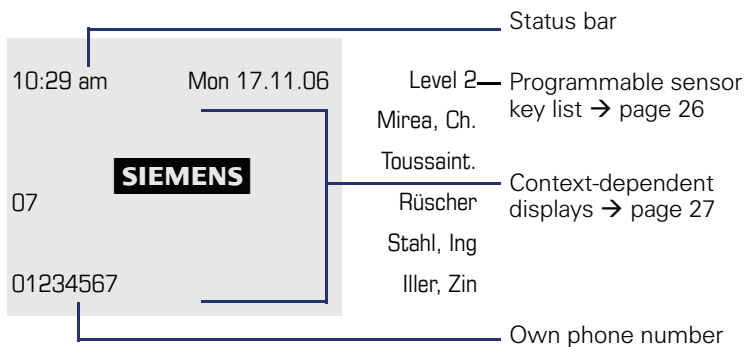

The left area contains the status bar on the first line and is followed by a five-line field for comprehensive context-specific displays. The right area is used for labeling the programmable sensor keys.

### Idle-display view and icons

The time, weekday, and date are displayed in the status bar.

In addition, different icons represent different situations and switches:

Icon	Explanation
	The ring tone is deactivated.
	The "Do not disturb" function is activated.
	The phone lock is activated.
	A mobile user is logged on to the telephone.
	The microphone is deactivated.

## Context-dependent displays

Depending on the situation at hand, the graphic display on your OpenStage phone displays different content, to which you can respond intuitively.

### Information on actual events



The following icons appear centered on the display when your phone is idle and signal current properties or events.

Example: You missed two calls in your absence.





You have two new voice messages that you can open by pressing  → page 34.

Icons for events

Icon	Explanation
	You received new voice messages.
	New entries have been added to the call lists.
	Local call forwarding is active.

### Context menus

An arrow beside a selected entry indicates the existence of a context menu that you can open by pressing the  or  buttons on the navigator (→ page 20). The range of functions available is situation-specific.



After a connection is set up – you are called or you make call – the context menu appears automatically under the current connection for the configured time (e.g. 20 seconds).

You can define how long the context menu should be displayed. You can deactivate the automatic display so that the  key on the navigator must be pressed to see the context menu of the connection → page 173.

### Idle display context menu

The following functions (where released) can be accessed by pressing the right key on the navigator:

Redial {1} 1234	—	First entry (selected when you call up the menu, if you have already dialed a phone number)
Ringer off		
<b>Do not disturb off</b>	—	Selected entry
Mobile logon	—	Only available when configured to support mobility
Cancel call backs		
Directed pickup		

### Pop-up menus

In many operating situations, suitable functions or information is offered in an automatic pop-up window.

Example: You set up a consultation call. The pop-up menu opens and offers suitable functions for selection with the navigator.

012345	Level 2
<b>Dial</b>	Mirea, Ch.
Redial {1}	Toussaint.
Retrieve held call	Rüscher
	Stahl, Ing
	Iller, Zin

A pop-up window automatically closes as soon as you have performed an action.

## Telephony interface

### Single-line view

Additional information is displayed in the telephony interface when your phone rings, when you dial a number or during a call, for instance.



The same information is available on multi-line telephones for the selected line in the line overview.

Example:

Icon indicating call status

— Smith Michael      3:16      Call duration

    L08912345678      Current call(s)

    Consultation

    Hold

    Blind transfer call      Context menu with situation-specific options

    Disconnect

### Icons for frequent call states

Icon	Explanation
—	The call is active
	The call has been disconnected
	You have placed the call on hold (e.g. consultation hold).
	Your call partner has placed the call on hold
	The voice connection is secure.
	The voice connection is not secure.



Detailed descriptions of the various functions can be found in the sections "Basic phone functions" → page 39 and "Enhanced phone functions" → page 76.

## Multi-line view

Two tabs are displayed on the telephony interface:





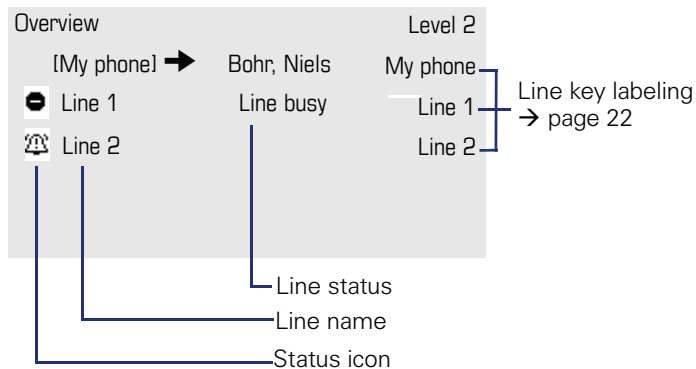

- "[My phone]" tab – represents the primary line or the line view of a selected line → page 29
- "Overview" tab – configurable overview of the secondary lines → page 22

To access the menu: Press the  key:

Example:



The status icons provide information about the state of the relevant line.

Icon	Explanation
	Call for the corresponding line.
	Call from a DSS line.
	Call for a line with suppressed ring tone → page 128.
	"Hold reminder" is activated → page 81.
	The line is currently not available.
	The line is busy.

 Please note the LED displays for the line keys → page 23.

## Context in the line overview

In the context menu of a selected line you have the following options with:

- Own free line
  - Select
  - View
- Own line with active call
  - Hold
  - Clear (replace handset)
  - View<sup>1</sup>
- Own line with held call
  - Retrieve
  - View
- Other free line
  - Select
  - View
- Other line with active call
  - Hold
  - Clear (replace handset)
  - View
- Other line with held call
  - Retrieve
  - View
- Other line busy
  - View

<sup>1</sup> The telephony view is displayed as a preview after a period of time set by the service personnel.

### Phonebooks

In addition to a local phonebook, there is a connection to the LDAP corporate directory if service personnel have made the necessary settings.

Both phonebooks can be accessed via the telephone menu (→ page 37). You can configure a sensor key for the local phonebook.

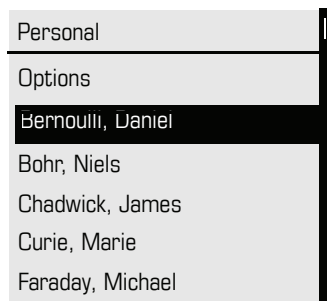

#### Search contacts

When in the phonebook or directory list view, press the keypad key that corresponds to the first letter of your search term. A field opens for you to enter the search term:

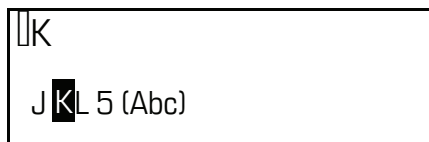

The cursor jumps to the first entry in the list that matches the character you entered in the search field.

### Personal phonebook

You can store up to 100 private contacts in your personal phonebook. These are displayed in alphabetical order in the phonebook list. How to create contacts is described in → page 102. A contacts consists of an entry with a "Last name", "First name" and a number.

#### Managing contacts

All saved contacts are listed in alphabetical order on the "Personal" menu.

You can use the "Options" context menu to

- create new contacts → page 102
- delete the entire phonebook list → page 103



## Using contacts

The following functions are available via the context menu of a selected contact:

- Calling a contact → page 92
- Editing a contact → page 102
- Deleting a contact → page 103

## LDAP directory

If you have access to an LDAP directory (contact the responsible service personnel), you can search contacts in a company-wide directory. A user-friendly, advanced search function is available for this.

### Searching for a contact

- Simple search → page 105
- Quick search → page 107.

### Using a contact

Calling a contact → page 92

## Messages

Depending on the type and configuration of your communications platform (contact the relevant administrator), messages from services, such as, HiPath Xpressions can be displayed in this list.

When new messages are received, a message appears (→ page 27) on the idle display and the LED on the  (→ page 19) key lights up.

**To access the menu:** Press the  key and use the navigator to select and confirm the relevant submenu.



## Voicemail

You will find voicemails in the **Messages directory**.

### **Messages Directory:**

The following default entry appears in the list: **Voice Mail**



**Alternative call:** Hold down the  key.

If your system is appropriately configured (contact the relevant administrator), you can call the voice mailbox directly and immediately play back the messages saved.

## Calls

This list appears as soon as you receive **new** missed calls if you select the option **Calls** in the Records menu. You can then scroll back to the **Calls** menu with the backspace key. The following calls or call attempts are logged as call lists:

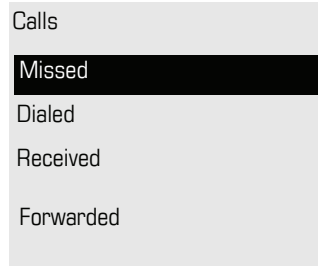

The number of missed calls and unchecked calls is shown on the idle display.

### Call lists

All calls to your phone are time-stamped and logged in consecutive order in the call lists.

Each call list may contain up to 30 entries. Once this limit is reached, the oldest entry in the log is deleted.

Multiple calls from the same number are only listed once. The number of call attempts is logged in the "Details" context menu and additionally in the "Missed Calls" log in the list display.

The list contains the phone number as well as the time of the last call.



Callers with suppressed numbers are listed as "Unknown" in the call lists.



Only calls to the primary line are received on multi-line phones (→ page 13).

---

Example of the **Missed** call list:

Missed	
Options →	
(Busch, Wilhelm	12:11
└11178	(2)
(Benz, Karl	10:25
└235689	(1)
(Lessing, Ephraim	7:22
└2568900	(1)

Time of call

Number of call attempts

Selected new entry with context menu

Old entry

### Call list options

You can select the following function in the **Options** context menu:  
Delete all → page 108

### Entry-specific context menu

You can select the following functions for an individual entry:

- Dial → page 93
- Details → page 108  
Call attempts with date and time (up to ten can be saved)
- Delete → page 108

## Telephone menu

Open the telephone menu using the  key.

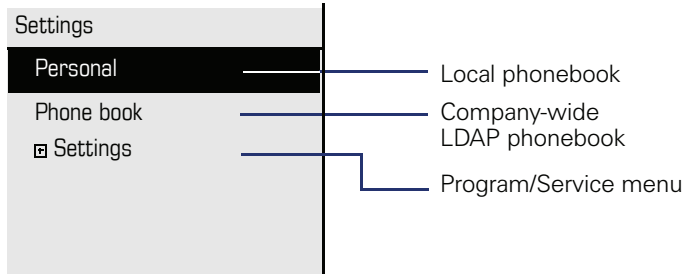

## Program/Service menu

You can make settings here as a user and use this menu to navigate to the password-protected administration area.

**Accessing the menu:** select **Settings** and confirm and then select and confirm the required menu using the navigator.

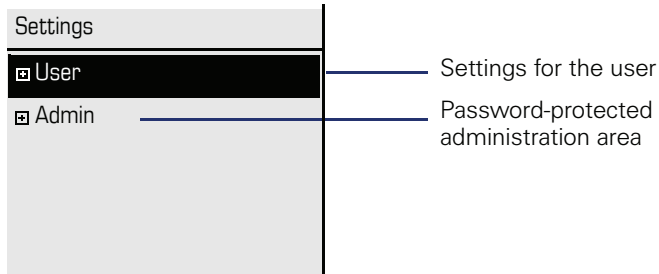

## User settings

You can use the "User" menu to make local function settings for your OpenStage and to configure the appearance of your display to your personal requirements.

Select one of the following menus with the navigator (→ page 20):

- "Date and time" → page 159
- "Audio" → page 163
- "Configuration" e.g. → page 77 or → page 98
- "Phone" → page 68 → page 157
- "Locality" → page 159
- "Security" → page 132
- "Network information" → page 38
- "Reset" → page 75

### Network information

Information about the IP address or name which was assigned to the phone in the network and therefore the HTML address of the web interface.



View information on the phone → page 174



Contact your service personnel or refer to the OpenStage Administration Manual for more on the network information values listed here.

---

### Reset phone



Personal settings made via the telephone menu or the web interface can be reset to factory settings. → page 175

### Administration

You can access the administration area via the "Admin" function and by entering the administration password.

Refer to the administration manual supplied with your phone for more detailed information on this topic.

### Control and monitoring function

A control or monitoring function can be activated on your phone for service purposes by remote maintenance.

#### Control function

Service personnel have the option to activate and deactivate features of the phone via remote maintenance. During maintenance the handset, microphone, loudspeaker and headset are deactivated. You are additionally informed on the display that the control function is active.

#### Monitoring function

In order to detect malfunctioning of a phone for example, the service personnel install a monitoring function. You can use your phone as normal during monitoring. However you will first be informed about the operation with a message on the display and prompted to allow monitoring.

If service personnel have activated a function on your phone, which continuously transmits operating data to a server, you will see the flashing icon  in the upper display line.

## Basic functions

---

 Please read carefully the introductory chapter "Getting to know your OpenStage phone" → page 14 before performing any of the steps described here on your phone.

---

## Secure voice transmission

**Prerequisite:** The secure voice communication option must be activated by your administrator.

If you call a party or receive a call from a party over a secure connection, a padlock icon<sup>1</sup> appears on the other party's row on your graphic display. You can opt to have voice connections that are no longer secure indicated by a brief alerting tone and a window with the message "Unencrypted call" (see → page 169).

## Answering a call

Your OpenStage phone rings with the tone signal set when an incoming call is received. The call is also visually signaled on the call display.

If transmitted, calling party information (name, phone number) appears on the graphic display.

---

 If you have set a pattern melody or a ringtone file → page 165 on your phone, it is possible that service personnel have preset a different pattern melody, pattern sequence or ringtone or deactivated the ringtone, depending on the call type (e.g. an external or internal call).

An incoming call will interrupt any ongoing telephone setting operations. When the call ends, you can press the  key to return to the point in the menu structure where you were interrupted.

---

1. Closed for secure or open for nonsecure voice communication

## Step by Step

if nec.  



### Answering a call via the handset

The phone rings. The caller is displayed.

Lift the handset.

Set the call volume.

### Answering a call via the loudspeaker (speakerphone mode)

The phone rings. The caller is displayed.

The pop-up menu opens:

Accept?

Select and confirm the option shown. The  key lights up.

or



Press the key shown. The key lights up.

The speakerphone function is activated.

if nec.  

Set the call volume.

#### Suggestions for using speakerphone mode:

- Tell the other party that speakerphone mode is active.
- Adjust the call volume while speakerphone mode is active.
- The ideal distance between the user and the phone in speakerphone mode is 50 cm.



## Step by Step

## Accepting a call via the headset

**Prerequisite:** A headset is connected.



Make sure your headset port is set up properly  
→ page 168.

The phone rings. The  key flashes.



Press the key shown.

if nec.  

Set the call volume.

## Answering calls automatically via the headset

**Prerequisite:** The service personnel have additionally configured a key with the "Auto-Headset function (AICS Zip tone) (→ page 69).



Press the "Auto-Headset" sensor key to activate automatic call answering. This key and the headset key illuminate.

A short acoustic signal is heard on the headset for a call and the connection is established.

If you want to manually answer calls again, deactivate the automatic answering function using the "Auto-Headset" key. Both keys are off.

## Step by Step

### Directed pickup

You can pick up a call signaled at an absent coworker's phone. If a colleague has placed a call on hold on their multi-line phone you can also pick up this call.

### Picking up call

**Prerequisite:** You know the coworker's internal phone number and the function is configured for you in Open-Scape Voice.

A coworker's phone rings.

Directed pickup?

Select and confirm the option shown in the idle phone's context menu.

or



Lift the handset.

or



Press the key shown.

Directed pickup?

Select and confirm the option shown.



Enter and confirm the relevant phone's internal number. You are connected to the calling party either via the handset or in speakerphone mode.

## Step by Step

## Picking up the held call:

**Prerequisite:** Your colleague has placed a call on hold on their multi-line phone → page 113. You know the co-worker's internal phone number and the function is configured for you in OpenScape Voice.

Directed pickup? ▾

Select and confirm the option shown in the idle phone's context menu.

or



Lift the handset.

or



Press the key shown.

Directed pickup? ▾

Select and confirm the option shown.



Enter and confirm the relevant phone's internal number. You are connected to your colleague's held call either via the handset or in speakerphone mode.

## Step by Step

### Switching from handset to speakerphone mode

 Make note of the two different processes and activate, if necessary, your preferred setting → page 167.

**Prerequisite:** You are conducting a call via the handset and the microphone and loudspeaker functions have been activated by administrator.

#### Standard mode

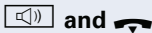

Hold down the key and replace the handset. Then release the key and proceed with your call.

#### US mode

If the country setting is set to US, you do not have to hold down the loudspeaker key when replacing the handset to switch to speakerphone mode.



Press the key shown.



Replace the handset. Proceed with your call.



 A secure voice communication is indicated by a closed padlock icon on the graphic display; a non-secure voice communication is indicated by an open padlock icon on the graphic display (see also → page 39)

### Switching from speakerphone mode to the handset

**Prerequisite:** You are conducting a call in speakerphone mode.



Lift the handset.



The key shown goes out.

## Step by Step

## Switching from headset to speakerphone mode

### In standard mode



Press and hold the key (open listening ist activated),



Press the key shown. Speakerphone mode is activated.

### In U.S. mode



Press the key shown.



Press the key shown. Speakerphone mode is activated.

## Open listening

You can let other people in the room join in on the call. Let the other party know that you have turned on the loudspeaker.

**Prerequisite:** You are conducting a call via the handset.

### Activating



Press the key shown.

### Deactivating



Press the lit key.

### Switching to speakerphone mode



Hold down the lit key and replace the handset.

## Step by Step

### Activating/deactivating the microphone

You can temporarily switch off the handset microphone to prevent the other party from listening in while you consult with someone in your office.

**Prerequisite:** You are conducting a call.

#### Deactivating the microphone



Press the key shown.

#### Activating the microphone



Press the lit key.

### Ending a call



Press the key shown.

**or**

Disconnect?

Select and confirm the option shown in the connections's context menu.

**or**



Lit key pressed

**or**

In speakerphone mode



Press the lit key.

## Step by Step

## Group call

Your administrator can incorporate multiple telephones in a call pickup group. If your telephone belongs to a pickup group, you can also accept calls intended for other members of the group.

A group call is displayed on the phone. Service personnel may have made the following settings for signaling:

Telephone status			Ring on group call = Yes	Ring on group call = No
Ringtone on	Silent		Ringtone Loudspeaker	Beep Loudspeaker
	in Connection	Handset	Ringtone Loudspeaker	Beep Handset
		Handset Open listening	Beep Handset and loudspeaker	Beep Handset and loudspeaker
		Headset	Ringtone Loudspeaker	Beep Headset
		Headset Open listening	Beep Headset and loudspeaker	Beep Headset and loudspeaker
		Speakerphone mode	Beep Loudspeaker	Beep Loudspeaker
Ringtone off	Silent		Nothing	Nothing
	in Connection	Handset	Nothing	Beep Handset
		Handset Open listening	Beep Handset and loudspeaker	Beep Handset and loudspeaker
		Headset	Nothing	Beep Headset
		Headset open listening	Beep Headset and loudspeaker	Beep Headset and loudspeaker
		Speakerphone mode	Beep Loudspeaker	Beep Loudspeaker

The volume settings can be found from → page 163.

### Step by Step

Further service personnel settings for group calls:

- The group call can be picked up both by lifting the handset and via the "Pickup call" menu option.
- The group call be picked up via the "Pickup call" menu option but **not** by just lifting the handset.
- A key is programmed for call pickup.

A group call is waiting and is indicated on the display by

**Pickup:** *Caller*

**for:** *Party*

#### Picking up a group call

The pop-up menu opens:

Pickup call?

Confirm the option shown.

**or**



Lift the handset (only if the appropriate function is set by your administrator)

**or**



Press the sensor key programmed with the "Call pickup" function (if configured). The speakerphone function is activated.

Ignore?

#### Ignoring a group call

Select and confirm the option shown. The phone stops signaling the group call.



## Step by Step

## Making calls

 If you selected the option "Busy When Dialing" → page 96, you will not be interrupted by an incoming call. In this case, the caller hears the busy signal.

## Off-hook dialing



Lift the handset.

Enter the number if nec. Use the navigator → page 20 to correct entries.

In the pop-up menu:

Confirm or wait until the dial delay expires. (see → page 94).

or

In the pop-up menu:

Select and confirm the option shown.

The connection is set up.

 If you are using a dial plan and **Immediate dialing** is set (see → page 51, dialing is automatically performed as soon as the character string entered matches an entry in the dial plan.

Dial

Redial {1} S. Hawking

## Step by Step

### On-hook dialing

The connection is set up with on-hook dialing via the loudspeaker (speakerphone mode) or via a connected headset.



Press the key shown.

**or**



Press the key if a headset is connected.

**and/or**



Enter the station number.



Press or wait until the dial delay expires. (see → page 94).

**or**

In the pop-up menu:

Redial {1} S. Hawking

Confirm the option shown.

### First enter the number

First enter the number. The loudspeaker or headset key illuminate when you enter the first digit.



Enter the station number. if nec. Use the navigator → page 20 to correct entries.

Dial

Confirm or wait until the dial delay expires. (see → page 94).

The connection is set up.



If you are using a dial plan and **Immediate dialing** is set (see → page 51, dialing is automatically performed as soon as the character string entered matches an entry in the dial plan.

## Step by Step

## Immediate dialing

Immediate dialing should only be activated if service personnel has configured and approved a dial plan.

Immediate dialing is deactivated by default. For this reason after entering the number you must either confirm the "Dial" option or wait until the dial delay expires to set up the connection. If **Immediate dialing** is configured, your call is automatically dialed as soon as the string entered matches an entry in the dial plan.

### Activating or deactivating immediate dialing



You can also configure this setting via the Web interface → page 176.



Press the key shown.

Settings

Select and confirm the option shown.

User

Select and confirm the option shown.

if nec.

Enter and confirm the User password.

Configuration

Select and confirm the option shown.

Outgoing calls

Select and confirm the option shown.

Immediate dialing

Select and confirm the option shown.

Yes

Select and confirm the option shown in the context menu.

Save & Exit

Confirm the option shown

## Step by Step

### Dialing using the hot or warm line function

Your service personnel can configure a hot or warm line for your phone.

If you lift the handset of the phone or press the loud-speaker key

- with a hot line immediately or
- with a warm line after a defined period of time,

a number specified by service personnel is dialed.

Examples:

- The phone in the lift immediately dials the reception number.
- The phone at a patient's bed dials the ward number e.g. after a minute if no other number is dialed.

## Step by Step

## Redial

### Redialing from the call list



Only calls to the primary line are received on multi-line phones (→ page 13).



Press the key shown.

You are automatically directed to the **Dialed** list in the **Calls** menu.

Niels, Bohr

07:06 am

Select and confirm the entry you want.

The phone number associated with the list entry is dialed.



or



Press the key shown.

Redial {1} S. Hawking

Select and confirm the option shown.

The last phone number entered is dialed.

Redial {1} S. Hawking

### Redialing from the idle menu

Select and confirm from the idle display context menu (→ page 28). The last phone number entered is dialed.



A secure voice communication is indicated by a closed padlock icon on the graphic display; a non-secure voice communication is indicated by an open padlock icon on the graphic display (see also → page 39).

## Step by Step

Consult



Disconnect & return

Disconnect

### Consulting a second party

You can call a second party while a call is in progress. The connection to the first party is placed on hold.

**Prerequisite:** You are conducting a call.

Select and confirm the option shown in the connections's context menu.

Call the second party.

---

 If you are using a dial plan and **Immediate dialing** is set (see → page 51, dialing is automatically performed as soon as the character string entered matches an entry in the dial plan).

---

### Ending or canceling a consultation call

Select and confirm the option shown in the second party's context menu.

The consultation call is disconnected. The call with the first party is resumed.

### Ending the first call

Select and confirm the option shown in the first call's context menu.

The connection to the second party remains active.

---

 If you want to use the **phonebook** or a **call list** for a consultation call, on the context menu select Consult instead of **Hold** or press the **Hold** key and open a phonebook or the required call list (→ page 102).

Alternatively you open a phonebook or call list without using the **Hold** function, the active call is automatically put on **Hold**.

---

## Step by Step

Alternate?

### Switching to the held party (alternating)

**Prerequisite:** You are conducting a consultation call.

Select and confirm the option shown in the connection's context menu.



It does not matter which context menu is open when alternating. The "Alternate" function appears in both menus (active and passive connection).

You can switch back and forth between two subscribers by repeatedly selecting and confirming "Alternate".

Disconnect?

### Ending an alternate operation

#### Disconnecting the held call:

Select and confirm the option shown in the held connection's context menu.

The held call is disconnected. The active call continues.

#### Disconnecting the active call:

Select and confirm the option shown in the active connection's context menu.

The active call is disconnected. The held call remains on hold and can be managed via the context menu.

Disconnect & return?

## Step by Step

### Putting on hold and retrieving successively or simultaneously

#### Putting an active call on hold

**Prerequisite:** You are conducting a consultation call → page 54 or have accepted a second call → page 83. The "Hold" sensor key must be configured → page 69

 Press the "Hold" key. The key lights up. The consultation or second call **and** the first call are put on hold.

#### Retrieving the first call



Switch to the first call.



Press the illuminated "Hold" key. You are connected with the other party. The consultation or second call continues on hold.

#### Retrieving the second call



Switch to the held consultation or second call.



Press the illuminated "Hold" key. You are connected with the other party. The first call is put on "Hold" again.



## Step by Step

## Connecting parties

You can connect the first party with the party you consulted, clearing down your connection to both parties in the process.

**Prerequisite:** You are conducting a consultation call → page 54 and call joining must be allowed → page 57.

Complete Xfer?

Select and confirm the option shown in the active connection's context menu.

The active and held calls are joined. The active call and the consultation call are cleared down.

or



or



## Connect by hanging up

Replace the handset or, if you are in speakerphone mode, press the loudspeaker key. The other two parties are now connected to one another.

## Allowing call joining

You can also configure this setting via the Web interface → page 176.



Press the key shown.



Settings

Select and confirm the option shown.

User

Select and confirm the option shown.

if nec.



Enter and confirm the User password.

Configuration

Select and confirm the option shown.

Connected calls

Select and confirm the option shown.

Allow call joining = Yes



Select and confirm the option shown.

Yes



Select and confirm the option shown in the context menu.

Options = Save & Exit



Confirm the option shown.

## Step by Step

### Call forwarding

You can forward calls for your phone to another phone.



On multi-line telephones (→ page 13), you can only configure call forwarding for the primary line.

Three forwarding conditions can be programmed in the forwarding menu:

- All Calls
- Busy
- No reply

Because of its direct impact, "All Calls" call forwarding has the highest priority followed by "No reply" and "Busy".

If active, "All Calls" call forwarding is indicated on the graphic display when the phone is idle.

Forwarded calls can be logged in a call list (see → page 35).

There are three Destination options in the **Edit call forwarding** menu. These destination options are assigned to the forwarding types.

All calls (off/on)

**Destination**

Busy (off/on)

**Destination**

No reply (off/on)

**Destination**

One phone number may already be assigned to each destination. The Destination option could then be Destination 12345, for instance.

## Step by Step

## Programming call forwarding

## Configuring destination phone numbers for call forwarding

You can configure up to five destination phone numbers for call forwarding. These destination phone numbers can then be assigned different forwarding types. You can then enable one of the forwarding types (→ page 61).



Press the key shown.

The pop-up menu opens:

Edit call forwarding

Select and confirm the option shown.

An overview of call forwarding settings appears.



You can also enter the call forwarding settings via the user menu (→ page 78).

Destination

Select the destination option for one of the following forwarding types:

- All calls
- Busy
- No reply

Confirm the destination selected.



You can use each of the three **Destination** options to save destination phone numbers for the relevant forwarding type.

Edit favourites

Select and confirm the option shown in the context menu.

Destination 1

Select and confirm the option shown.



Enter and confirm the destination phone number.

Define additional destination phone numbers for destination 2 to 5, as necessary.

Save & Exit

Select and confirm the option shown.

## Step by Step



Press the key shown.

The pop-up menu opens:

Edit call forwarding

Select and confirm the option shown.

An overview of call forwarding settings appears.

Destination

Select the destination option for one of the following forwarding types:

- All calls
- Busy
- No reply

Confirm the destination selected.

08972228596

Select and confirm a destination number from the list.

Save & Exit

Select and confirm the option shown.

### Defining the ring duration before call forwarding on no reply

You can define how often the phone should ring before the "No reply" form of call forwarding activates.



This setting is only available if the "Server features" function was deactivated by the administrator.



You can also configure this setting via the Web interface → page 176.



Press the key shown.

The pop-up menu opens:

Edit call forwarding

Select and confirm the option shown.

An overview of call forwarding settings appears.

Duration

Select and confirm the option shown.



Enter a value for the duration.

Save & Exit

Select and confirm the option shown.

## Step by Step

## Activating/deactivating call forwarding



You can also configure this setting via the Web interface → page 176.

**Prerequisite:** At least one destination phone number is programmed (→ page 60).



Press the key shown.

The pop-up menu opens:

Edit call forwarding

Select and confirm the option shown.

An overview of call forwarding settings appears.

All calls

Select and confirm the option shown.

or

Busy

Select and confirm the option shown.

or

No reply

Select and confirm the option shown.

On

Select and confirm "On" or "Off" in the context menu.

Save & Exit

Select and confirm the option shown.

## Step by Step

### Activating call forwarding for all calls

Use the  function key to activate call forwarding for all calls.



You can also configure this setting via the Web interface → page 176.

**Prerequisite:** There is at least one forwarding destination programmed → page 59.



Press the key shown.

The pop-up menu opens:

Accept

Select and confirm the option shown. The  key lights up. Call forwarding is activated.

If the phone is idle, the call forwarding icon  appears on the graphic display with the destination phone number.

### Deactivating call forwarding for all calls



Press the lit key.

The pop-up menu opens:

The pop-up menu disappears after around five seconds and the  key goes out.

or

Accept

Select and confirm the option shown. Call forwarding is deactivated.

## Step by Step

### Call forwarding chain

Sometimes calls to a station are forwarded to another station which also has call forwarding or DND activated. This can create a call forwarding chain consisting of several telephones where the last member of the chain is your phone.

A popup window opens on your phone's screen with the following information:

- Who is calling
- Who forwarded first or last.
- The reason for the forwarding is displayed by an icon.

You can set whether the station that forwarded first or last is displayed (see → page 79).

## Step by Step

### Callback

You can request a callback if the station called is busy or if nobody answers.

You receive a callback when the other party's line becomes free.



This option must be activated by your administrator.



On multi-line telephones → page 13, only the callback requests for your primary line are logged.

### Requesting callback

**Prerequisite:** The station called is busy or nobody answers.

In the pop-up menu:

Call back?

Select and confirm the option shown.

### Deleting callback requests

You can delete scheduled callback requests if you no longer need to return a call, for example, at the end of the working day.

**Prerequisite:** At least one callback was requested.

Cancel call backs?

Select and confirm the option shown in the idle display (→ page 28) context menu.

Disconnect? ▲

Confirm in the pop-up menu. All callback requests are deleted.



## Step by Step



## Responding to a callback

**Prerequisite:** A callback was requested. Your phone rings and station information appears on the graphic display.

The pop-up menu opens:

### Accepting a callback

Select and confirm the option shown.

### Rejecting a callback

Select and confirm the option shown.

The callback request is deleted. The caller hears the busy signal. The caller's phone number is added to the missed calls list.

### Forwarding a callback

Select and confirm the option shown.

Enter and confirm the phone number.

## Step by Step



You can also configure this setting via the Web interface  
→ page 176.



Press the key shown.

User

Select and confirm the option shown.

User

Select and confirm the option shown.

**if nec.** 

Enter and confirm the User password.

Configuration

Select and confirm the option shown.

Outgoing calls

Select and confirm the option shown.

Callback: busy

Select and confirm the option shown.

**or**

Callback: no reply

Select and confirm the option shown.

Yes

Select and confirm the option shown in the context menu.

Save & Exit

Select and confirm the option shown.

## Step by Step

## Calling back missed calls

Calls received while you are absent are indicated by a message on the idle display (→ page 27). The  function key also lights up.

Missed calls are logged in the missed calls list. This list provides information on the missed call and lets you call back the number directly (call lists, see also → page 35).



On multi-line telephones → page 13, only the calls missed on your primary line are logged.



Press the key shown.

Calls

Select and confirm the option shown.

Niels, Bohr 20.05 10:06

Select and confirm the appropriate list entry. The phone number associated with the list entry is dialed.

If no new calls are listed, the call list menu is offered under **Calls** → page 108.

## Step by Step

### Programmable sensor keys

The phone features a range of functions that can, if required, be programmed on programmable sensor keys.

The phone comes with 6 sensor keys, all of which can be programmed on two separate levels.

The sensor key for switching between the two sensor key levels is preassigned (shift key). This programmable sensor key should be maintained where possible so you can switch between the two programmable sensor key levels.

The labels for the sensor keys are displayed on the right edge of the display.

The sensor keys can also be programmed via the web-interface (→ page 176).

### List of available functions

- |                           |                         |
|---------------------------|-------------------------|
| 1. Delete (not assigned.) | 17. Group pickup        |
| 2. Selected dialling      | 18. Repertory dial      |
| 3. Repeat dialling        | 19. Feature toggle      |
| 4. Forward all calls      | 20. Mobility            |
| 5. Forward no reply       | 21. Directed pickup     |
| 6. Forward busy           | 22. Callback            |
| 7. Ringer off             | 23. Cancel callbacks    |
| 8. Hold                   | 24. Consultation        |
| 9. Alternate              | 25. DSS                 |
| 10. Blind transfer call   | 26. Call Waiting toggle |
| 11. Transfer call         | 27. Immediate ring      |
| 12. Deflecting            | 28. Preview             |
| 13. Shift                 | 29. AICS Zip tone       |
| 14. Conference            | 30. Server feature      |
| 15. Headset               | 31. Launch application  |
| 16. Do not disturb        | 32. Send URL            |

## Step by Step

### Programming sensor keys



You can also configure this setting via the Web interface → page 176.

### Beginning programming

#### Directly via a sensor key



Hold down the sensor key to which a function should be assigned until the programming prompt is displayed.



If the prompt is not displayed or a programmed function is not executed, then you can only launch key programming via the user menu (ask your service personnel about the current setting).

OK

Confirm to begin programming. The sensor key illuminates continuously.

or

#### Via the user menu

You can also program keys via the user menu.



Press the key shown.

Settings

Select and confirm the option shown.

User

Select and confirm the option shown.

if nec.



Enter and confirm the User password.

Phone

Select and confirm the option shown.

Program keys

Select and confirm the option shown. You are prompted to press the key you wish to program.



Press the sensor key you want to program with a function. The sensor key illuminates continuously.

## Step by Step

Normal

### Beginning programming

Select and confirm the option shown to program the first level.

or

Shifted

Select and confirm the option shown to program the second level.

Do not disturb

Select and confirm the required function in the list (e. g. Do not disturb).

Label

Select and confirm the option shown if you want to change the label on the graphic display.



Enter and confirm the label you want.

Save & Exit

Select and confirm the option shown.

### Programming enhanced functions

#### Repertory dial

Hold down the sensor key to which a function should be assigned until the programming prompt is displayed.



If the prompt is not displayed or a programmed function is not executed, then you can only launch key programming via the user menu (ask your service personnel about the current setting).

OK

Confirm to begin programming. The sensor key illuminates continuously.



You can also configure this setting via the Web interface → page 176.

Normal

Select and confirm the option shown to program the first level for instance.

Repertory dial

Select and confirm the function in the context menu.

Label

Select and confirm the option shown if you want to change the label on the graphic display.



Enter and confirm the label you want.

## Step by Step

Setting



Select and confirm this option to enter a destination phone number.

Enter and confirm a stations's destination phone number.

You can select and insert special characters in the dialing sequence:

- « Clear call
- ~ Make consultation
- » Make normal call
- Pause

The pop-up menu also offers the following functions:

- Move cursor right and left
- Copy
- Paste
- Mode selection
- Cancel
- OK

Save & Exit

Select and confirm the option shown.



The repertory dial can be up to 40 characters long.

## Step by Step

### Feature toggle

Only available for Hunt group functions (→ page 148).

Hold down the sensor key to which a function should be assigned until the programming prompt is displayed.



If the prompt is not displayed or a programmed function is not executed, then you can only launch key programming via the user menu (ask your service personnel about the current setting).

OK

Confirm to begin programming. The sensor key illuminates continuously.



You can also configure this setting via the Web interface → page 176.

Normal

Select and confirm the option shown to program the first level for instance.

Feature toggle

Select and confirm the function in the context menu.

Label

Select and confirm to change the key labeling.



Enter and confirm the label you want.

Setting

Select and confirm this option to enter a code.



Enter and confirm the code, for example: \*96 (contact your service personnel).

Save & Exit

Select and confirm the option shown.



## Step by Step

### Forwarding

 Hold down the sensor key to which a function should be assigned until the programming prompt is displayed.

 If the prompt is not displayed or a programmed function is not executed, then you can only launch key programming via the user menu (ask your service personnel about the current setting).

OK

Confirm to begin programming. The sensor key illuminates continuously.



You can also configure this setting via the Web interface → page 176.

Normal

Select and confirm the option shown to program the first level for instance.

Forward all calls

Select a forwarding type:

- Forward all calls
- Forward no reply
- Forward busy

Select and confirm the function in the context menu.

Label

Select and confirm the option shown if you want to change the label on the graphic display.



Accept or edit the label and confirm.

Setting

Select and confirm this option to enter the forwarding destination.



Enter and confirm the phone number of the forwarding destination.

Save & Exit

Select and confirm the option shown.

## Step by Step

### Using sensor keys

The use of programmed functions depends on the phone's status. The relevant display appears once you have pressed a sensor key.

#### Example 1: Calling saved number

**Prerequisite:** The idle menu is displayed on the graphic display.

■ Press the sensor key for a saved number. The connection is set up.

#### Example 2: Call Waiting toggle Activating/deactivating

You can press a key to activate or deactivate call waiting functionality, even during a call. The prerequisite for this is that a second call is permitted (→ page 85). By default a second call is permitted.



Press the "Call Waiting toggle" sensor key. The sensor key goes out. The second call function is deactivated. The call is rejected or forwarded.

#### Example 3: Immediate ring

This function allows you to switch the preset delay (→ page 125) on and off for all line keys. By default the delay is set, the key does not illuminate.

■ Press the "Immediate ring" sensor key. The sensor key illuminates. The delay ringtone is disabled. An incoming call rings immediately regardless of what delay time is configured.

Step by Step

## Resetting sensor keys

You can reset sensor keys you configured to factory settings (see also → page 175).



Settings

Press the key shown.

Select and confirm the option shown.

User

Select and confirm the option shown.

if nec.

Enter and confirm the user password.

Reset

Select and confirm the option shown to switch to the **Reset user data** menu.

Function key data

Select the option shown.

Yes

Select and confirm the option shown in the context menu to delete the content of all sensor keys.

Reset selected user data

Select and confirm "Reset selected user data". The contents of the sensor keys you configured are deleted.



Sensor keys which can only be configured by service personnel remain unchanged

## Step by Step

# Enhanced phone functions

## Incoming calls

### Accepting calls via the headset

**Prerequisite:** The headset is connected.



The LED flashes when a call is received. Press the key shown. Conduct call.

### Ending the call:



Press the key shown. The LED goes out.

## Deflecting a call

### Using call deflection

**Prerequisite:** An incoming call is displayed or signaled.

In the pop-up menu:

Deflect

Select and confirm the option shown.

The call is immediately deflected if a destination phone number is programmed (→ page 77).

**or**

If you did not set a phone number when programming call deflection, a pop-up menu appears prompting you to enter a destination phone number for call deflection.



Enter and confirm the destination phone number. The call is deflected.

## Step by Step

**Permitting call deflection**

You can also configure this setting via the Web interface → page 176.



Press the key shown.

Settings

Select and confirm the option shown.

User

Select and confirm the option shown.

if nec.

Enter and confirm the User password.

Configuration

Select and confirm the option shown.

Incoming calls

Select and confirm the option shown.

Deflecting

Select and confirm the option shown.

Allow deflection

Select and confirm the option shown.

Yes

Select and confirm the option shown in the context menu.

Default destination

Select and confirm the option shown.



Enter and confirm the phone number to which the station should be deflected.



Entering a destination phone number is not mandatory when call deflection is active. If you want to deflect an incoming call, you are prompted to enter a destination phone number if there is none stored.

**or Deflecting to a DSS number**

A call can be deflected to a direct station selection (DSS) subscriber using the DSS key, if the key is configured and the deflect function is activated by your administrator → page 118.

Deflect to DSS: Yes

Information only, as set by service personnel: Yes or No.

## Step by Step

Reject

### Rejecting a call

You can reject an incoming call.

In the pop-up menu:

Select and confirm the option shown.  
The caller hears a busy signal.



If the rejected caller's phone number is transmitted, it is saved in the call list. You can then call this party back at a later time.

### Configuring call forwarding



You can also enter the call forwarding settings via the Forwarding key (→ page 59).



Press the key shown.

Settings

Select and confirm the option shown.

User

Select and confirm the option shown.

if nec. 

Enter and confirm the User password.

Configuration

Select and confirm the option shown.

Incoming calls

Select and confirm the option shown.

Forwarding

Select and confirm the option shown.

For a description of the settings, see the chapter "Call forwarding" (→ page 58).

### Configuring call forwarding

Settings

Select and confirm the option shown.

For a description of the settings, see the chapter "Call forwarding" (→ page 58).

## Step by Step

### Setting alerts

Use the Call forward alerts menu to enable and disable visual and audible alerts for call forwarding (not possible with the Forwarding key).

Alerts

Select and confirm the option shown.

Visual alerts= No

Select the option shown.

Yes

Select and confirm the option shown in the Yes/No context menu.

**or**

Audible alerts= No

Select the option shown.

Yes

Select and confirm the option shown in the Yes/No context menu.

**or**

Forwarding station... Last

Select the option shown.

Display last

Select and confirm **Display last/Display first**.

Options = Save & Exit

Select and confirm the option shown.

## Step by Step

Hold

or



Press the "Hold" key. The key lights up. (The "Hold" sensor key must be configured → page 69.)

Reconnect

or



Press the illuminated "Hold" key. (The "Hold" sensor key must be configured → page 69.)

### Placing a call on hold

You can use this function to place an ongoing call on hold, for instance, to prevent the other party overhearing a conversation with a colleague in the same room. The held party hears music on hold if **Music on hold** is active on this party's phone (→ page 82).

**Prerequisite:** You are conducting a call.

Select and confirm the option shown in the connections context menu.

### Retrieving a held call:

Select and confirm the option shown in the connections context menu.

### Using line keys

On multi-line telephones you can use the line keys to place ongoing calls on hold.



Press the corresponding trunk key. The line key LED starts flickering. The call is now on hold.

### Retrieving a held call:



Press the corresponding trunk key. The line key LED lights up. The call is retrieved.



The LED display → page 23 or status display on the "Overview" tab → page 30 indicates to other multi-line telephones on which this line is also configured, that the call is on hold. These phones can then pick up the call.

### Held call wait status

After placing a call on hold, you can replace the handset and then decide if the call should be retrieved or disconnected.



## Step by Step

Retrieve held call

or

Disconnect



Settings

User

if nec.



Configuration

Connected calls?

Allow hold rem.?

Yes

Save & Exit

**Prerequisite:** You placed a call on hold and replaced the handset.

In the pop-up menu:

Select and confirm the option shown to resume the call in speakerphone mode.

Select and confirm the option shown to disconnect the call.

### Activating/deactivating the hold reminder tone

You can also configure this setting via the Web interface → page 176.

Press the key shown.

Select and confirm the option shown.

Select and confirm the option shown.

Enter and confirm the User password.

Select and confirm the option shown.

Select and confirm the option shown.

Select and confirm the option shown.

Select and confirm the option shown in the context menu.

Select and confirm the option shown.

### Setting the hold reminder time

Use the "Hold reminder" function to set the length of the timeout before an automatic reminder is issued about a held call.

The minimum value is 1, that is, the reminder is output after one minute. The maximum value is 99 minutes. Press 0 to deactivate the reminder.



You can also configure this setting via the Web interface → page 176.

### Step by Step



Press the key shown.

User

Select and confirm the option shown.

**if nec.**

Enter and confirm the User password.

Configuration

Select and confirm the option shown.

Connected calls?

Select and confirm the option shown.

Hold rem. delay

Select and confirm the option shown.



Enter a value between 3 and 15 and confirm.

Save & Exit

Select and confirm the option shown.

### Music on hold

Music on hold is played back when you are placed on hold by another party, providing this option is active.



You can also configure this setting via the Web interface → page 176.



Press the key shown.

Settings

Select and confirm the option shown.

User

Select and confirm the option shown.

**if nec.**

Enter and confirm the User password.

Configuration

Select and confirm the option shown.

Connected calls

Select and confirm the option shown.

Music on hold

Select and confirm the option shown.

Yes

Select and confirm the option shown in the context menu.

Save & Exit

Select and confirm the option shown.

## Step by Step

## Call waiting (second call)

You can accept a second incoming call in the course of an ongoing call. The caller hears the on-hook signal while you hear a call-waiting signal tone.

You can ignore or accept the second call. Before you accept the second call, you can end the first call or place it on hold for subsequent retrieval.

You can block the second call or the signal tone (→ page 85).

### Accepting a second call

**Prerequisite:** You are conducting a call and call waiting is allowed (→ page 85).

In the pop-up menu:

Select and confirm the option shown.

Accept

You can talk to the second party.

The connection to the first party is on hold.

You can still

- toggle between an initial and second call or
- put on hold and retrieve second and first call successively → page 56  
or
- initiate a conference

### Consultation call from second call

If the second call is your active call you can initiate a consultation call from it.

From a consultation call in the second call you can

- initiate a conference
- toggle between the second call and a consultation call
- put on hold and retrieve second and first call successively → page 56
- transfer a call
- disconnect the calls again

During a consultation in the second call, the first call is parked and can only be unparked when the consultation or second call ends or these calls were connected.

Disconnect & return

Select and confirm the option shown in the second call's context menu. The call to this station is disconnected and the call to the first station is reconnected.

## Step by Step

Ignore

### Ignoring second call

**Prerequisite:** You are conducting a call and call waiting is allowed (→ page 85).

In the pop-up menu:

Select and confirm the option shown.

The caller still hears the on-hook signal. You can subsequently Accept, Reject or Deflect the second call.

While the ignored second call continues to wait, from the active call you can:

- make a consultation call
- initiate a conference
- toggle between the consultation call and your call party
- transfer a call

A third call would be rejected with the busy signal

If you have disconnected the first call, the ignored second call rings like a normal call.

### Rejecting a second call

**Prerequisite:** You are conducting a call and call waiting is allowed (→ page 85).

In the pop-up menu:

Reject

Select and confirm the option shown.

The second call is rejected. The caller hears the busy signal. The caller's phone number is added to the missed calls list.

### Deflecting a second call

**Prerequisite:** You are conducting a call and call waiting is allowed (→ page 85).

In the pop-up menu:

Deflect

Select and confirm the option shown.

Enter and confirm the phone number.

The second call is deflected to the destination specified. You are reconnected with the first party.



## Step by Step

### Connecting parties

Select and confirm the option shown in the active connection's context menu. The other two parties are now connected to one another. You can now hang up or dial another number for instance.

### or Connect by hanging up

**Prerequisite:** Connecting by hanging up is activated (ask your service personnel) and "Toggle associate" must be set to "Yes" (→ page 86). Before you can be connected by hanging up you must have toggled at least twice (→ page 55).

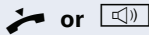

Replace the handset or, if you are in speakerphone mode, press the loudspeaker key. The other two parties are now connected to one another.

### Allowing call waiting



If the Call waiting (second call) function is deactivated, a caller hears the busy signal if you are already conducting a call.

**Prerequisite:** The option was programmed by your administrator.



You can also configure this setting via the Web interface → page 176.



Press the key shown.

Select and confirm the option shown.

Select and confirm the option shown.

if nec.

Enter and confirm the User password.

Select and confirm the option shown.

Select and confirm the option shown.

Select and confirm the option shown.

Select and confirm the option shown.

### Step by Step

Yes

Select and confirm the option shown.

Save & Exit

Select and confirm the option shown.

When **Allow call waiting** is activated, you can toggle the configured sensor key to switch call waiting on/off (→ page 85).

#### Toggling associate

Set the "Toggle associate" function to Yes if you want to connect to a second or pickup call by hanging up.



You can also configure this setting via the Web interface → page 176.



Press the key shown.

Settings

Select and confirm the option shown.

User

Select and confirm the option shown.

**if nec.** 

User passwordEnter and confirm the .

Configuration

Select and confirm the option shown.

Connected calls

Select and confirm the option shown.

Toggling associate

Select and confirm the option shown.

Yes

Select and confirm the option shown in the context menu.

Save & Exit

Select and confirm the option shown.

## Step by Step

## Transferring a call

You can transfer your current call to another party with or without consultation.

### Blind transfer

**Prerequisite:** You are conducting a call. The options "Allow call transfer" and "Transfer on ring" were allowed (→ page 88).

Blind transfer

Select and confirm the option shown in the connections's context menu.



Enter and confirm the phone number of the second party to whom you want to transfer the call.



The graphic display returns to idle following successful transfer.

### Transferring with consultation

You can announce a call to a recipient before transferring it.

**Prerequisite:** You are conducting a call. The options "Allow call transfer" and "Transfer on ring" were allowed (→ page 88).

Consultation

Select and confirm the option shown in the connections's context menu. The call is placed on hold.



Enter the phone number of the party to whom you want to transfer the call.

Dial

Confirm the option shown.

#### If the party answers:

Announce the call you want to transfer.

Complete Xfer

Select and confirm the option shown in the connections's context menu.

#### If the party does not answer:

You do not have to wait for the second party to answer before you can transfer the call.

Complete transfer

Select and confirm the option shown in the connections's context menu.

or

Replace the handset or, if speakerphone mode is active, press the lit  key to transfer the call.

### Step by Step

If the party does not answer, you will be called back by the first party.

#### Allowing call transfer

You can also configure this setting via the Web interface → page 176.

Press the key shown.

Select and confirm the option shown.

Select and confirm the option shown.

**if nec.**  Enter and confirm the User password.

Select and confirm the option shown.

Select and confirm the option shown.

Select and confirm the option shown.

Select and confirm the option shown in the context menu.

Select and confirm the option shown.

Settings

User

Configuration

Connected calls

Allow call transfer

Yes

Save & Exit



## Step by Step

**Allowing "Transfer on Ring"**

If this option is allowed, you can activate call transfer by replacing the handset even before the called party answers.



You can also configure this setting via the Web interface → page 176.



Press the key shown.

Settings

Select and confirm the option shown.

User

Select and confirm the option shown.

if nec.



Enter and confirm the User password.

Configuration

Select and confirm the option shown.

Outgoing calls

Select and confirm the option shown.

Transfer on ring

Select and confirm the option shown.

Yes

Select and confirm the option shown in the context menu.

Save & Exit

Select and confirm the option shown.

## Step by Step

### CTI calls

#### Beep on auto-answer

Speakerphone mode activates automatically on your phone if you use a CTI application (such as Outlook) to dial a number when Auto Answer is active. If Auto Answer is not active, the phone rings first and you have to press the loudspeaker key or lift the handset to set up the call. This setting also defines whether or not incoming calls are automatically accepted. If the function is active, an alert beep sounds when an incoming call is automatically accepted.

Information on the operation of the configured CTI application can be found in the corresponding user guide.



You can also configure this setting via the Web interface → page 176.

**Prerequisite:** The option was programmed by your administrator.



Press the key shown.

Settings

Select and confirm the option shown.

User

Select and confirm the option shown.

if nec.

Enter and confirm the User password.

Configuration

Select and confirm the option shown.

Incoming calls

Select and confirm the option shown.

CTI calls

Select and confirm the option shown.

Auto-answer

Select and confirm the option shown.

Yes

Select and confirm the option shown.

Beep on auto-answer

Select and confirm the option shown.

Yes

Select and confirm the option shown.

## Step by Step

Save & Exit

Select and confirm the option shown.

### Beep on auto-reconnect

You can reconnect a held call both via the CTI application and via the phone. A beep sounds when you toggle between an active call and a held call when the function is active.

**Prerequisite:** The option was programmed by your administrator.



You can also configure this setting via the Web interface → page 176.



Press the key shown.

Settings

Select and confirm the option shown.

User

Select and confirm the option shown.

if nec.



Enter and confirm the User password.

Configuration

Select and confirm the option shown.

Incoming calls

Select and confirm the option shown.

CTI calls

Select and confirm the option shown.

Beep on auto-unhold

Select and confirm the option shown.

Yes

Select and confirm the option shown.

Save & Exit

Select and confirm the option shown.

## Step by Step

### Making calls

If you want to dial a call from a phonebook or a call list, you should not lift the handset or press the loudspeaker or headset key before.

### Dialing with the DDS key

You can program frequently used phone numbers on programmable keys (→ page 69). If you press a DSS key, the associated contact or phone number appears and dialing is initiated.

**Prerequisite:** A direct destination key is programmed → page 69.

 Press the programmed DDS key. Dialing is initiated.

### Dialing from the local phonebook

 Press the key shown.

Personal

Confirm the option shown.

or

 Press the configured sensor key "Personal" for the local phonebook ( → page 69).

Niels, Bohr

Select and confirm the entry you want. The phone number is dialed.

Extensive information on the local phonebook and on searching for stations can be found from → page 102.

### Dialing from the LDAP database

**Prerequisite:** You searched for and selected an entry in the LDAP database (→ page 105).

Niels, Bohr

Select the entry you want.

Dial

Select and confirm the option shown in the context menu. The connection is set up.

**Step by Step****Dialing a phone number from a list**

The following call lists are available in the "Calls" directory:

- Missed
- Dialed
- Received
- Forwarded



For a detailed description of the call lists, see  
→ page 35.



Press the key shown.

Calls

Select and confirm the option shown.

Dialed

Select and confirm the required call list.

Niels, Bohr

07:06am

Select and confirm the entry you want. The phone number associated with the list entry is dialed.

## Step by Step

### Using autodial delay

A number is automatically dialed after a set delay starting from the entry of the number's last digit. The autodial delay can be used:

- when dialing in idle mode
- when deflecting an incoming call
- Consultation
- when transferring an answered call.

The delay can be reduced by performing one of the following activities:



- Press the key shown. This always works.



- Lift the handset (off-hook). This only works if the phone number was entered when the phone was idle or if it was entered for a consultation call when the handset was off hook.



- Press the key shown. This only works if the phone number was entered when the phone was idle and the loudspeaker key was not lit or if the phone number was entered for a consultation call and the loudspeaker key was not lit.



---

If an emergency number is preset by your administrator, the autodial delay for this phone number is reduced to one second.

---



---

Automatic dial delay does not work if you are using a dial plan and **Immediate dialing** is configured (see → page 51). The number is automatically dialed as soon as the string entered matches an entry in the dial plan.

---

## Step by Step

## Settings for autodial delay



You can also configure this setting via the Web interface → page 176.



The setting does not affect automatic emergency number dialing.

If you select **Autodial delay**, you must either confirm the "Dial" option, press the loudspeaker key or wait until the autodial delay expires to set up a call when dialing with the handset on hook.



Press the key shown.

Settings

Select and confirm the option shown.

User

Select and confirm the option shown.

if nec.

Enter and confirm the User password.

Configuration

Select and confirm the option shown.

Outgoing calls

Select and confirm the option shown.

Autodial delay

Select and confirm the option shown.



Specify a value and confirm your entry.

Save & Exit

Select and confirm the option shown.

### Step by Step

#### Allowing "Busy When Dialling"

If you activate this function, an incoming call received while you are performing dialling is rejected. The caller then hears the busy signal.



You can also configure this setting via the Web interface → page 176.



Press the key shown.

Settings

Select and confirm the option shown.

User

Select and confirm the option shown.

**if nec.**

Enter and confirm the User password.

Configuration

Select and confirm the option shown.

Outgoing calls

Select and confirm the option shown.

Busy when dialling

Select and confirm the option shown.

Yes

Select and confirm the option shown in the context menu.

Save & Exit

Select and confirm the option shown.



This setup option can also be found under "Handling" in the "Incoming calls" menu.

---



## Step by Step

## Conference

### Local conference

This type of conference is also referred to as a three-party conference. It involves up to three participants.

**Prerequisite:** You are conducting a consultation call → page 54 or have accepted a second call → page 83, and the conference function is active → page 98.

#### Initiating a local conference



You can initiate a conference by calling the "Conference" function in the context menu of either the active or held call.

Conference?

Select and confirm the option shown in the connection's context menu. You are connected to both parties at once.

User

Select the connection you want to clear down on the display.

Disconnect

Select and confirm the option shown in the context menu. You are now involved in a one-to-one call with the remaining call party.



If you already are involved in a secure connection with a party when you initiate a consultation call, the original party is placed on hold. The new consultation connection can be either secure or non-secure. However, the first connection remains secure even if all three parties are now joined together in a conference.

The entire conference is nonsecure if the connection to at least one of the parties is not secure (see also → page 39).

The relevant padlock icon appears on the "Conference" row.

## Step by Step

Exit Conf?

### Ending a local conference

#### Allowing call partners to continue a conference after you exit

**Prerequisite:** The function "Allow join in conference" (→ page 99) was activated.

Select and confirm the option shown in the "Conference" context menu.

or

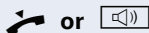

Lift the handset or press the loudspeaker key. Both call partners remain connected. You are disconnected from the conference call.

End Conf?

### Disconnecting a party

Select and confirm any of the connections in the context menu.

Both connections are cleared down – the conference is cleared down.

### Allowing a local conference

This option allows or blocks the "Conference" function.

You can also configure this setting via the Web interface → page 176.



Press the key shown.



Settings

Select and confirm the option shown.

User

Select and confirm the option shown.

if nec.

Enter and confirm the User password.

Configuration

Select and confirm the option shown.

Connected calls

Select and confirm the option shown.

Allow conferences

Select and confirm the option shown.

Yes

Select and confirm the option shown in the context menu.

Save & Exit

Select and confirm the option shown.

## Step by Step

**Allowing joining in a local conference**

You can use this option to decide whether or not your call partners are allowed to join calls after you exit the conference call.



You can also configure this setting via the Web interface → page 176.



Press the key shown.

Settings

Select and confirm the option shown.

User

Select and confirm the option shown.

**if nec.**

Enter and confirm the User password.

Configuration

Select and confirm the option shown.

Connected calls

Select and confirm the option shown.

Join in conferences

Select and confirm the option shown.

Yes

Select and confirm the option shown in the context menu.

Save & Exit

Select and confirm the option shown.

### Step by Step

Conference?

## System-based conference

This type of conference is also referred to as a large conference. It can include up to ten parties.

**Prerequisite:** You are conducting a consultation call → page 54 or you have accepted a second call → page 83, and the "centralized conference" feature was configured by your administrator.

### Establishing a conference

Select and confirm the option shown in the connection's context menu. You are connected to the first two parties at once. The conference is displayed with the current participants. You can now:

- initiate a consultation call
- put the conference on hold
- leave the conference.

Consultation?

### Conducting a consultation call

Select and confirm the option shown in the "Conference" context menu. If the party answers, you can:

- toggle between the party and the conference
- connect the consultation call to another called party
- end the consultation call and return to the conference
- add the consultation call party to the conference.

Conference?

### Adding a party

**Prerequisite:** You are conducting a consultation call and the conference is on hold.

Select and confirm the option shown in the consultation call's context menu. The party is added to the conference. Only the conference and all current participants are now displayed.

Hold?

### Putting the conference on hold

Select and confirm the option shown in the "Conference" context menu. The conference is placed on hold and you can consult with someone in your office, for instance.

## Step by Step

Exit Conf?



### Leaving a conference

Select and confirm the option shown in the "Conference" context menu. You are disconnected from the conference call and can dial another number, for instance. The other call partners remain connected.



If using the "centralized conference" option, the Conference row contains a closed padlock icon for a secure voice connection and an open padlock icon for a nonsecure voice connection (→ page 39).

The display depends on whether the conference server supports secure voice communication. The appropriate display is set by the conference server.

## Step by Step

# Phonebooks and call lists

## Local phonebook

The personal phonebook is restricted to 100 entries. If you have configured a sensor key for the local phonebook, you can open it using this sensor key (→ page 69).

### Creating a new contact

You can also create contacts via the web interface → page 176.



Press the key shown.

Personal

Confirm to open the local phonebook.

Options

Select the option shown.

New contact

Confirm the option shown in the context menu.



Fill in the three fields

- Last name
- First name
- Number

accordingly.

Save & Exit

Select and confirm to save the phonebook entry.

### Editing a contact

You can also edit contacts via the web interface → page 176.



Press the key shown.

Personal

Confirm to open the local phonebook.

Niels, Bohr

Select the required entry.

Details

Select and confirm the option shown in the context menu.

Last name

Select and confirm, for example the Last name field.

## Step by Step



Change and confirm .

Save & Exit

Select and confirm the option shown.

### Deleting a contact

You can also delete contacts via the web interface → page 176.



Press the key shown.

Personal

Confirm to open the local phonebook.

Niels, Bohr

Select the required entry.

Delete

Select and confirm the option shown in the context menu. Then confirm the Delete or cancel the process.

### Deleting all contacts

You can also delete the contacts via the web interface → page 176.



Press the key shown.

Personal

Confirm to open the local phonebook.

Options

Is displayed

Delete all

Select and confirm the option shown in the context menu.

## Step by Step



Personal

Options



Kirsch, Erika

Kramer, Elisabeth

## Searching for a contact

Press the key shown.

Confirm to open the local phonebook.

Is displayed

Enter the first letter of the name you are searching, e.g. k.

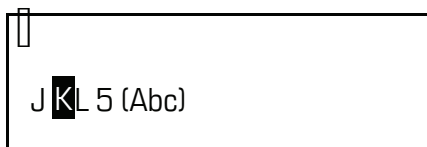

The name first found in which the first letter is K is displayed. If you are looking for a name that begins with Kr, also enter the second letter in the search field:

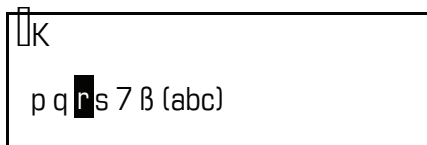

The first name with the initial letters Kr is displayed.

You can also browse the phonebook with the **navigator** until you reach the required station. → page 20.



## Step by Step

## LDAP database

You can search an LDAP database (corporate phonebook) for contact entries if you can reach this database over your network and your access was correctly configured by your service personnel.

You can perform searches using the name (simple search) or different information on an entry (advanced search), for example, job title or department name.

## Finding an LDAP entry



Corporate

Press the key shown.

Select and confirm to open the company-wide Phone book "Corporate".

Find

Select and confirm the option shown in the **Options** context menu

Last name

Select and confirm the required search field (for example, "Last name").



Enter a search text. If you for example only enter the first letter of the last name, all entries with this initial letter are displayed.

Find

Select and confirm when you have filled out one or more search fields. The search begins. If the entry you searched for is found, you can dial or view the entry details.

## Step by Step

Details

Delete

Qualifier



## Extended LDAP editing

### Viewing an LDAP entry

**Prerequisite:** You found and selected an LDAP entry (see above).

Select and confirm the option shown in the context menu for the entry. All fields of the entry are displayed.

### Resetting the search fields

**Prerequisite:** The search fields are listed.

Select and confirm the option shown in the **Options** context menu. You can now enter the search criteria for the search.

### Defining a qualifier before a search

Prior to a search, you can select which qualifiers should also appear in the output list in the **Options** context menu.

Select and confirm the option shown. You may choose between the following criteria:

- No qualifier
- Job function
- Address 1
- Email
- Business 1
- Mobile
- Business 2
- Private
- Company
- Address 2

Select and confirm the desired qualifier.

Exit the list.

## Step by Step

Corporate

Options

Kirsch, Erika

## Quick search

Press the key shown.

Select and confirm to open the company-wide Phone book.

Is displayed

Enter the first letter of the name you are looking for, e.g. "k".

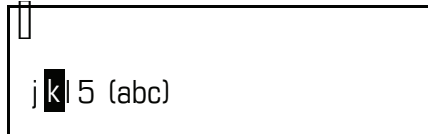

Do not enter any further characters. After a predefined period of time or after pressing the **OK** key all available names with the corresponding initial letter are displayed.

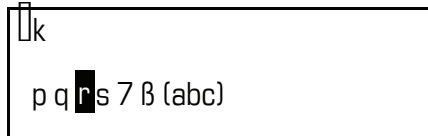

You can restrict the output by entering the second and other letters. The **#** key is used to switch between letters and numbers. The **←** key is used to delete individual characters.

When entering extended characters you can control the search individually. For the selection of extended characters firstly press the **\*a** key.

Rule list:

Character	Description
#	Searches for the exact string before the extended character
,	You can enter first and last name separately using a comma. A search is carried out for the last name (possibly using a wildcard) and the first name with the first character after the comma.
*	Wildcard. This searches for the character entered and all possible subsequent characters

## Step by Step

### Call lists

For a detailed description of the different call lists, see → page 35.

### Editing entries

#### Selecting an entry



Press the key shown.

Calls

Select and confirm the option shown.

Missed

For instance, select and confirm the list of missed calls → page 67.

The list is sorted chronologically, with the most recent caller first.

You can use the **navigator** to scroll through the list.

Niels, Bohr 22.05 13:22

Select the list entry.

#### Displaying details

Details

Select and confirm the option shown in the context menu.

For display and information shown.

Delete

#### Deleting an entry

Select and confirm the option shown in the context menu. The entry is deleted.

### Deleting all entries



Press the key shown.

Calls

Select and confirm the option shown.

Dialed

For instance, select and confirm the list of dialed numbers.

Options

Select the option shown.

Delete All

Select and confirm the option shown in the context menu.

All entries in the list displayed are deleted.

## Step by Step

## Making calls with multiple lines

You can use your OpenStage 40 as a multi-line phone. If you have any questions regarding how to configure your OpenStage phone as a multi-line phone, please contact your administrator.

The following is a description of the telephony scenarios for multi-line phones. To facilitate comprehension, you should familiarize yourself with the enhanced telephony application and how to use the line keys beforehand. Furthermore, you can specify individual settings for your multi-line telephone. Refer to the following sections for a detailed description of the individual components:

- Introduction to multi-line phones → page 13
- Lines and line keys → page 22
- Multi-line telephony interface → page 30
- Individual settings → page 124

## Incoming calls

Depending on your individual settings, you will be notified of incoming calls → page 165.

## Accepting calls for the primary line

In this case, the telephone behaves in the same way as a single-line telephone. See → page 39 and → page 76.

## Accepting calls for secondary lines

**Prerequisite:** The secondary line is configured on your multi-line telephone.

### Using the handset



Lift the handset.



Conduct call.



The line that rings is automatically selected. If calls are ringing on more than one line, you will be connected to the line that has been ringing the longest.

### Step by Step



Accept

#### Using the line keys

Press the flashing trunk key.

Speakerphone mode.

Select and confirm the option shown.

Speakerphone mode.

#### Making calls

You must seize a line before you can make calls on a multi-line telephone.

Trunk seizure can be configured on an individual basis. Your administrator can determine if the lines on your telephone can be automatically seized and with which priority.



If you have seized a secondary line, this line is reserved for you for making calls for a specific period as defined by the administrator. No other user can seize this line during this period, even if the line is also assigned to this user's telephone.



Lift the handset or press the speakerphone mode or headset key.



Press the required trunk key.

or



Press the key shown to open the **Overview** tab  
→ page 30.

Line 2

Select and confirm the required line (e.g. line 2). The selected line is displayed on the screen.



Enter the phone number or use redial, for example. The connection is set up.

## Step by Step

### Automatic trunk seizure

**Prerequisite:** Your administrator has configured automatic trunk seizure.



Lift the handset or press the speakerphone mode or headset key.



The line defined during configuration is seized.



Enter the station number. The connection is set up.

### Dialing the last dialed number

Regardless of the line used, the last number dialed on your telephone is displayed for redialing in the selected number's context menu.

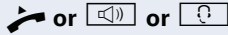

Lift the handset or press the speakerphone mode or headset key.



Press the required line key (→ page 110).

In the pop-up menu:

Redial {1} 12345

Confirm the option shown. The connection is set up.

### Forwarding calls on primary line

The call forwarding can only be activated for the primary line. Which call forwards are possible, how they are configured and activated can be found from → page 58.

#### Call forwarding information

**Prerequisite:** Your service personnel has activated "Forwarding shown".

If you have activated one of the forwarding types on your phone for the primary line and a station calls, a popup window with the following information opens:

- Who is calling
- The forwarding destination.

### Step by Step

## During calls

### Making and receiving calls on a single line

If you only use one line on your multi-line telephone to make calls, and you receive calls on the same line, the phone operates in the same way as a single-line telephone:

- Redial → page 53
- Consultation → page 54
- Toggle/Connect → page 55
- Callback → page 64
- Hold → page 80
- Call waiting (second call) → page 83
- Transferring a call → page 86
- Conference → page 97

Functions available exclusively for the primary line:

- Call lists → page 35
- Voicemail → page 34
- Call forwarding → page 58
- Do not disturb → page 130



Depending on your individual settings, you will be notified of incoming calls → page 128.

### Making and receiving calls with multiple lines

#### Accepting a waiting call



Depending on the settings for "Rollover", you will be notified of incoming calls → page 128.

**Prerequisite:** You are conducting a call. At the same time, a call is incoming on another line.



Call on line 1.



Press the line key for line 2. The call on line 1 is placed on hold.



## Step by Step



All multi-line users that share the line on which the call is being held (→ page 22) can now pick up the held call. To prevent other users from answering the held call, you must place the call on "Consultation" hold → page 54.

Depending on the setting made by your administrator, you may have to press the trunk key twice to accept the call on the other line. The first call is either placed on hold or released depending on the setting.



Conduct call on line 2.



End call on line 2.



Press line key for line 1.



Retrieve call on line 1.

### Putting a line on hold

On a multi-line telephone you can use the line keys to place calls on hold.

**Prerequisite:** You are conducting a call.



Press the call-line sensor key.



- The LED line key flashes.
- The LED line displays the hold status on all multi-line phones to which the line is connected.
- On phones connected to the line, a user can press the relevant line key and accept the held call.

During a consultation call or after accepting a waiting call the hold function cannot be used.

## Step by Step

### Lines with hot or warm line function

Your service personnel can configure a hot or warm line for the primary and secondary line.

The function is activated when on

- the primary line  
you pick up the phone's handset or press the line or loudspeaker key
- the secondary line  
you press the line key.

A number specified by you is dialed with a hot line immediately and with a warm line after a specific time.

Examples:

- The phone in the lift immediately dials the reception number.
- The phone at a patient's bed dials the ward number e.g. after a minute if no other number is dialed.

### Entering a number for the hot and warm line function

Specify which number should be dialed when the hot or warm line function is activated.



You can also configure this setting via the Web interface → page 176.



Press the key shown.

Settings

Select and confirm the option shown.

User

Select and confirm the option shown.

if nec.

User password Enter and confirm the .

Configuration

Select and confirm the option shown.

Keypad

Select and confirm the option shown.

Lines

Select and confirm the option shown.

Line

Select and confirm the required line in the context menu.

Hot warm dest

Select and confirm the option shown.

## Step by Step



Enter and confirm the destination.

Save & Exit

Select and confirm the option shown.

## Busy override

A station of a line trunk group is on a call. It's primary line is configured as a secondary line on your phone. This line now has the status "busy." You can join in the call by pressing the illuminated key of this line (see also → page 22).

**Prerequisite:** A secondary line is configured on your multi-line phone and busy override is enabled for you.

The key of secondary line illuminates – it is busy. You want to join in the call.



Press the lit key. A conference is established. You are connected to the parties on the secondary line. The key continues to illuminate and the conference is shown on the display.



If there is already a conference on the secondary line you are connected to this conference. The conference is shown on the display.

You can now:

- Put the secondary line on hold
- Leave the conference on the secondary line
- Make consultation call
- Accept a second call
- Alternate between a new call party and a conference on the secondary line.
- Include a call party from a consultation or a second call in the conference.

### Step by Step

## Direct station selection keys

Apart from line keys, administrator can also configure direct station selection (DSS) keys. You can use a DSS key to call an internal station directly, pick up calls for this station or forward calls directly to it.

### Calling a station directly

You cannot use DSS if the user is on another call (flashing LED).

#### Calling from the idle menu



Press the relevant DSS key.

or



Press the key shown to open the **Overview** tab  
→ page 30.

DSS call 1

Select and confirm the DSS line. The key lights up and a connection is established.



The administrator can configure the DSS key so that the connection is also established when the DSS station has activated do-not-disturb or call forwarding.

### Consultation with the DSS station

**Prerequisite:** You are conducting a call and administrator have configured the DSS key for consultation.



Press the relevant DSS key for the consultation. The key lights up and a connection is established. If the called party answers, you can toggle, transfer the first call or initiate a conference.



If administrator have configured transfer instead of consultation, you can only transfer the current call to the DSS station.

## Step by Step

### Call pickup

You can pick up calls for another DSS station. If a call is waiting on their line, the LED flashes.

#### Indirect pickup

**Prerequisite:** The auto-answer function must be deactivated → page 90.



Press the DSS key. The call is routed to your primary line and rings.

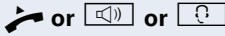

Lift the handset or press the speakerphone mode or headset key. You are connected with the other party.

#### Rejecting a call

**Prerequisite:** administrator must activate the reject option for DSS keys and auto-answer must be deactivated → page 90.



Press the DSS key. The call is routed to your primary line and rings.

Reject

Select and confirm the option shown in the pop-up menu. The caller hears a busy signal.

#### Direct pickup

**Prerequisite:** The auto-answer function must be activated → page 90.



Press the DSS key. The call is routed to your primary line and you are immediately connected with the other party via speakerphone.

## Step by Step

### Deflecting a call to a DSS station

**Prerequisite:** The deflect function must be approved for DSS keys. For information on the current setting, see → page 77.

If you receive a call on one of your lines, you can immediately deflect it to the DSS station.





Your phone rings and a line key flashes.



Press the relevant DSS key. The call is deflected to the DSS station. If the DSS station does not answer, you can pick up the call by pressing the DSS key.

### LED display on DSS keys

DSS Key	Explanation
	<b>Off:</b> The line is in idle mode.
	<b>Flashes:</b> You can accept a call for the DSS station via the key. The call is routed to your primary line when the call is accepted.
	<b>Illuminates:</b> The line is busy. Provided that second call is activated you can still reach the DSS station via the key. It can accept your call as a second call.

## Making calls in an executive-secretary team

An executive-secretary team is configured by the relevant service personnel and may include up to four executive and up to two secretary telephones.

### Sample scenarios

This example assumes that two executive and two secretary phones are configured. Calls for the executives are forwarded immediately to the respective secretary phone. A secretary then connects the call with or without consultation to the responsible executive using the direct station selection key.

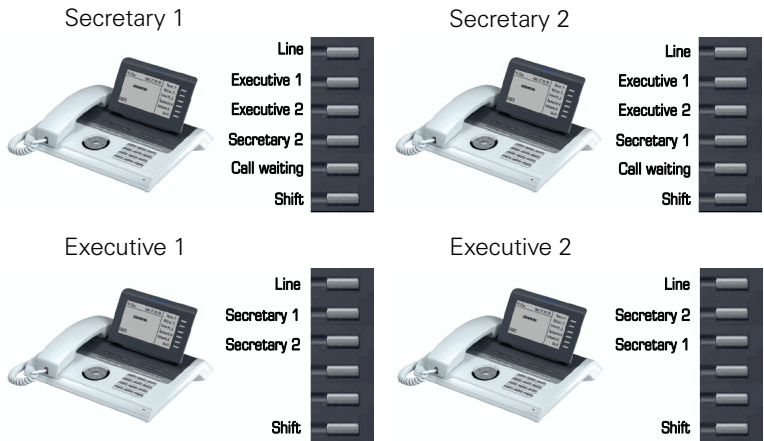

### Prerequisites:

The following call forwards are configured (→ page 58 ):

- For All calls from Executive 1 to Secretary 1
- For All calls from Executive 2 to Secretary 2
- Forward on Busy and forward on No reply from Secretary 1 to Secretary 2
- Forward on Busy and forward on No reply from Secretary 2 to Secretary 1

"Allow call waiting" should be activated on the secretaries' phones (→ page 85). This function can optionally be activated and deactivated using a key if a key has been configured for it.

Line and direct station selection keys have been configured by service personnel and "Transfer on hangup" and server features have been activated.

### Step by Step

#### Accepting a call

Incoming calls for the executives should be forwarded immediately to the assigned secretary and answered there. The line overview (→ page 123) shows whether the executive has activated call forwarding.

#### Accepting calls at the secretary phone

An incoming call for "Executive 1" rings at the assigned "Secretary 1".

The line key of the "Secretary 1" phone flashes.



The "Secretary 1" direct station selection key on the "Executive 1" phone also flashes.



Press the line key to answer the call. The station answers. The line key flashes **rapidly**.



The "Secretary 1" direct station selection key on the "Executive 1" phone illuminates.

#### Early call pickup by Executive 1

An incoming call for "Executive 1" rings on "Secretary 1". The "Secretary 1" direct station selection key on the "Executive 1" phone flashes. The "Secretary 1" has not yet answered the call. Before the call is forwarded to "Secretary 2", "Executive 1" picks up the call early.



Press the "Secretary 1" direct station selection key on the "Executive 1" key to answer the call.



If for example a call for "Secretary 2" on "Executive 2" is not answered, "Secretary 1" or "Executive 1" can pick up the call early



## Step by Step

**Forward to Secretary 2**

An incoming call for "Executive 1" rings at the assigned "Secretary 1". The call is **not** answered. After a specified period the call is forwarded to "Secretary 2". The line key of the "Secretary 2" flashes and it rings.



Press the line key on the "Secretary 2" phone to answer the call. The station answers. The "Secretary 2" direct station selection key on the "Executive 1" phone illuminates.



If "Secretary 1" is busy, the call is forwarded immediately to "Secretary 2" if:

- a consultation call is being made or
- "Allow call waiting" is deactivated.

**Second call**

If "Secretary 1" receives a second call, this can be accepted, ignored, forwarded or rejected. Detailed information on this can be found from → page 83.

If the second call is ignored, it is forwarded to "Secretary 2" after a certain period of time.

If the second call was answered, it can be forwarded using consultation or the direct station selection keys.

**Connecting a call**

If e. g. the "Secretary 1" answered a call, it can forward the call using the direct station selection keys to the following telephones:

- Executive 1
- Executive 2
- Secretary 2.

The following examples show connections to "Executive 1".

### Step by Step



#### Connecting with consultation

Press the DSS "Executive 1" key. "Executive 1" answers. Announce the call.

Press the hang-up, loudspeaker or headset key.



You can also select "Complete Xfer" from the context menu.

Complete transfer

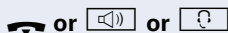

#### Connecting without consultation

Press the DSS "Executive 1" key. "Executive 1" does not answer.

Select and confirm the option shown in the pop-up menu.

Press the hang-up, loudspeaker or headset key. The "Executive 1" phone rings.

If "Executive 1" does not answer the call, after a specified time the number is redialed ( see also → page 86).



The "Executive 1" direct station selection key on the "Secretary 1" phone illuminates.

Disconnect & return



#### Consultation without connecting

Press the DSS "Executive 1" key. "Executive 1" answers. Transferring is not wanted. The "Secretary 1" takes the call back

Select and confirm the option shown in the pop-up menu. The "Secretary 1" is reconnected with the caller.

#### Toggle, disconnect or conference

During a consultation call "Secretary 1" can toggle between "Executive 1" and the caller, can initiate a conference or disconnect one of the two call parties. More on this subject can be found on pages → page 55 and → page 97.

Step by Step

### DSS keys can be used

These keys are configured in such a way that every phone can be reached by every phone in the group. The DSS keys are also used for consultation calls.

- Press a team member's DSS key. The relevant phone rings and the party answers.

### Using line overview

To view the status of the lines, change from the "My phone" tab to the "Overview" tab on the phone screen with the ↵ key.

Overview	Line
Line Bohr, Niels	Executive 1
☎ DSS:Executive 2 Line busy	Executive 2
📞 DSS:Secretary 2 0123456	Secretary 2
DSS:Executive 1 Line forwarded	
	Shift key

Further information on the line status can be found on → page 30.

The "executive-secretary" team can be expanded with line keys by the service personnel. These lines keys however have no influence on the behavior of the "executive-secretary" configuration.

## Step by Step

### Settings for multi-line phones (keyset)

The details for each keyset line contain supplementary information for the user. The following uneditable fields are displayed:

- Address
  - Displays the phone number for the line
- Ring on/off
  - Shows whether the ringer is activated for this line
- Selection sequence

Displays the priority of each line seizure when the handset is lifted or the loudspeaker key for this line is pressed

### Displaying the line in the "Overview" tab

Specify here if the selected line should be displayed in the "Overview" tab.



You can also configure this setting via the Web interface → page 176.



Press the key shown.

Settings

Select and confirm the option shown.

User

Select and confirm the option shown.

if nec.

Enter and confirm the User password.

Configuration

Select and confirm the option shown.

Keyset

Select and confirm the option shown.

Lines

Select and confirm the option shown.

Line 1

Select and confirm the required line (for example, line 1).

Allow in overview

Select and confirm the option shown.

Yes

Select and confirm the option shown in the context menu.

Save & Exit

Select and confirm the option shown.

## Step by Step

### Setting the time for a delayed ringer

Specify the length of time before a held call should be signaled on a line.



You can also configure this setting via the Web interface → page 176.



Press the key shown.

Settings

Select and confirm the option shown.

User

Select and confirm the option shown.

if nec.



Enter and confirm the User password.

Configuration

Select and confirm the option shown.

Keypad

Select and confirm the option shown.

Lines

Select and confirm the option shown.

Line 1

Select and confirm the required line (for example, line 1).

Ring delay

Select and confirm the option shown.



Enter and confirm a delay value.

Save & Exit

Select and confirm the option shown.

You can activate and deactivate the set delay time for all line keys using a function key → page 74.

## Step by Step

### Configuring the "Overview" tab display

Specify here the sequence in which the individual lines in the "Overview" tab should appear on the display.



You can also configure this setting via the Web interface → page 176.



Press the key shown.

Settings

Select and confirm the option shown.

User

Select and confirm the option shown.

if nec.

Enter and confirm the User password.

Configuration

Select and confirm the option shown.

Keyset

Select and confirm the option shown.

Overview

Select and confirm the option shown.

All lines that are displayed in the overview are listed.

Line 1

Select and confirm the required line (for example, line 1).

Select one of the following options from the context menu to move an individual line:

- Move up
- Move down
- Move to top
- Move to bottom

**or**

Use FPK order

Select and confirm the option shown to arrange the lines in the same sequence as the line keys

**or**

Add all lines

Select and confirm the option shown to display all line keys in the overview.

---

The setting made for "Allow in overview" (→ page 124) is disregarded here.

---

Save & Exit

Select and confirm the option shown.

## Step by Step

## Line preview

### Activating via the line keys

**Prerequisite:** You are already on a call on one line and a further call rings on the secondary line. Service personnel have activated line preview.



Press the flashing trunk key. A popup window opens and you receive information about the caller.



Press the flashing line key to answer the second call.



If service personnel have deactivated the line preview, a call is answered immediately on a second line when the line key is pressed, without showing caller information.

### Activating via preview key

**Prerequisite:** You have programmed a sensor key with the "Preview" → page 69 . Your service personnel have activated the preview function.

#### Preview for a call:

You are already conducting a call on one line. A further call rings on a secondary line.



Press the "Preview" sensor key. A popup window opens and you receive information about the caller.



Press the "Preview" sensor key again to hide the preview or wait until the popup closes itself after a specified period of time.

#### Permanent preview



Press the "Preview" key in idle mode. This way the preview for all lines with "preview mode" remains active until you press the "Preview" sensor key again.

### Step by Step

#### Rollover for a line

Your administrator can determine how rollover calls are to be signaled.



or



You hear a **special advisory tone** via the currently active microphone and the corresponding line key blinks.

or



The **ringer melody set sounds briefly** (approx. 3 seconds) via the loudspeaker and the corresponding line key blinks.



You hear a short **notification tone**



The ringer melody is not played in speakerphone mode.

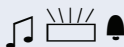

The telephone rings using the configured call signal, the corresponding line key blinks, and a pop-up menu containing the available information is displayed.



## Step by Step

## Privacy/security

### Deactivating the ringer

You can deactivate your ring tone if you do not want to be disturbed by your phone ringing.



Hold down the key shown.

The "Ringer off" icon appears in the status bar on the idle display → page 26.



Hold down the key once again to reactivate the ringer. The icon disappears.

You can also switch the function on and off using the option in the idle menu.

Ringer off?

Select and confirm the option shown.

or

### Deactivating the ring tone via sensor key

**Prerequisite:** The "Ringer off" sensor key must be configured → page 69.



Press the "Ringer off" sensor key.

An incoming call is signaled by a single ring tone burst.



Press the lit sensor key once more to deactivate the "Ringer off" function.

## Step by Step

### Do not disturb

If "Do not disturb" is activated, your telephone will not ring. The caller hears the busy signal.



On multi-line telephones (→ page 13) you can only activate the "Do not disturb" function for your primary line.

**Prerequisite:** A programmable key is assigned the function "Do Not Disturb" (see → page 69). "Do not disturb" must be activated (→ page 131).

### Enabling "Do not disturb" via a key



Press the "Do not disturb" programmable key.



Press the lit programmable key once more to deactivate the "Do not disturb" function.



You can also use the programmable key to activate the "Do not disturb" function during a call or deactivate it when an incoming call is being signaled.

or

### Enabling "Do not disturb" via the idle menu

Do not disturb on

Select and confirm the option shown in the idle menu. The "Do not disturb" icon appears in the header.

or

Do not disturb off

Select and confirm the option shown in the idle menu. The "Do not disturb" icon is deleted.

## Step by Step

## Allowing "Do not disturb"



You can also configure this setting via the Web interface  
→ page 176.



Press the key shown.

Settings

Select and confirm the option shown.

User

Select and confirm the option shown.

**if nec.**



Enter and confirm the User password.

Configuration

Select and confirm the option shown.

Incoming calls

Select and confirm the option shown.

Handling

Select and confirm the option shown.

Allow DND

Select and confirm the option shown.

Yes

Select and confirm the option shown.

Save & Exit

Select and confirm the option shown.

## Step by Step

# Security

## User password

Your User password protects your individual configurations, including your language settings. You can also use the User password to lock your telephone → page 134.



The preset password "000000" corresponds to a blank password. In other words, the phone cannot be locked and the user menu is **not** password protected (see also → page 133).



You can also change the user password via the Web interface → page 176.



Press the key shown.

Settings

Select and confirm the option shown.

User

Select and confirm the option shown.

if nec.

Change and confirm User password.

Security

Select and confirm the option shown.

User password

Select and confirm the option shown.



Specify a new password (at least six characters, text entry, see → page 25) and confirm your entry.

Confirm password

Select and confirm the option shown.



Save & Exit

Enter the password again and confirm.

Select and confirm the option shown.

## Step by Step

**Deactivating the user password**

You can deactivate the phone's password prompt if a password has already been configured.

 Deactivating the password prompt does not apply to the web-interface → page 176, Open-Stage Manager or CTI applications that use a password prompt. The password "000000" must be entered here.

If you deactivate the user password, you are **not** able to lock the phone → page 134 and the user menu is **not** password-protected.



Settings

Press the key shown.

Select and confirm the option shown.

User

Select and confirm the option shown.

if nec.



Change and confirm User password.

Security

Select and confirm the option shown.

User password

Select and confirm the option shown.

if nec.



Press the key to delete the existing password.



Enter six zeros ("000000") to deactivate the password (for text input, see → page 25) and confirm.

Confirm password

Select and confirm the option shown.



Enter six zeros ("000000") once again and confirm.

Save &amp; Exit

Select and confirm the option shown.

## Step by Step

### Locking the phone

You can lock your phone to protect it against unauthorized access. In this way, no one can make calls or change your user settings unless they know your user password.

Predefined numbers from the dial plan can still be dialed when the phone is locked. For more information, contact your administrator.

If an emergency number is entered by administrator, "Emergency call" appears on the display when you use the line on a locked phone. **Sie können die Notrufnummer auch über die Wähltastatur eingeben.**



You can only lock the phone if you set a user password (→ page 132). The password for this should not match the default "000000".

### Activating the phone lock



Hold down the key shown until "Phone lock: Confirm locking the phone" appears.

Confirm lock

Confirm the option shown. The phone is locked.

or



Press the key shown.

User

Select and confirm the option shown.



Enter and confirm the User password.

Security

Select and confirm the option shown.

Phone lock

Select and confirm the option shown.

Yes

Select and confirm the option shown.

Save & Exit

Select and confirm the option shown. The phone is locked.

## Step by Step

Unlock phone



### Unlocking the phone

Confirm the option shown.

Enter and confirm the User password. The phone is unlocked if the password is correct.



Emergency numbers and predefined numbers from the dial plan can be dialed from a locked phone.

If the telephone is locked redial keys cannot be used. This also applies when emergency numbers or predefined numbers from the dial plan are stored on them.

### Step by Step

## Mobility

**Prerequisite:** Your phone is configured to support mobility by administrator. A DLS server is available in the LAN and its address is entered in the phone.

### Mobility scenarios

When you log on to your phone, or any other mobility-enabled phone, the following scenarios are possible:

#### Logging on and off at the same phone

- Log on as a mobility user → page 137.
- Log off as a mobility user → page 138.

#### Logging on and off at different phones

In these cases, administrator may have made the following settings:

- Log on at a remote phone with forced logon, when the user is still logged on at that phone → page 139.
- Delayed logon at a remote phone with forced logon, when the user is still logged on at that phone and the phone is busy → page 140.



## Step by Step

## Logging on and off at the same phone

### Logging on to the phone

No other mobility user is logged on.

#### Logon via a key

If a sensor key is configured for Mobility .

 Press the "Mobility" sensor key.

#### or Logon via the context menu

Mobile logon

Select and confirm the option shown in the idle display (→ page 29) of the context menu.

Mobility ID

The **Mobility logon** dialog appears.

You are prompted to enter your mobility ID.



Enter and confirm mobility ID – usually a phone number.

Enter password

You are prompted to enter the password.



Enter and confirm the user password.

The following messages appear on the display:

- Logging on mobile user
- Validating
- Registering
- Downloading user data

Once logon is complete, the "Mobility" program key LED lights up and the mobility icon  appears in the graphic display next to the mobile phone number.

## Step by Step

### Logging off from the phone

**Prerequisite:** You are logged on as a mobility user.

#### Logoff via key

If a program key is configured for Mobility.



Press the "Mobility" program key.

or

#### Logon via the context menu

Mobile logoff

Select and confirm the option shown in the idle display → page 29 of the context menu.

Mobile logoff

Is displayed. You briefly have the option to cancel the logoff, otherwise the logoff process is launched.

In the graphic display, the following messages appear:

- Logging off mobile user
- Uploading user profile
- Registering
- Downloading user data

After you have logged off, the mobility icon  is hidden.

## Step by Step

## Logging on at different telephones

An attempted login is rejected if the user is already logged on to another phone and "Logon with forced logoff" is disabled for the mobility user.

## Logging on with forced logoff at a remote phone

If the user is already logged on at another phone and the remote phone is busy, the logon is rejected.

If, however, your service personnel enabled "Forced logoff during call" without setting a time, the system does not consider whether or not the remote phone is busy.

### Logon via a key

If a program key is configured for Mobility.

Press the "Mobility" program key.

or

### Logon via the context menu

Select and confirm the option shown in the idle display → page 29 context menu.

You are prompted to enter your mobility ID.

Enter and confirm mobility ID – usually a phone number.

You are prompted to enter the password.

Enter and confirm the user password.

The following mobility messages appear in the display:

- Validating
- Logging off elsewhere
- Registering
- Downloading user data

The logoff is simultaneously displayed on the remote phone. Once logon is complete, the "Mobility" program key LED lights up and the mobility icon appears in the graphic display .

Mobile logon

Mobility ID

Enter password

## Step by Step

### Logging on with forced, delayed logoff at a remote phone

If the remote phone is busy and your service personnel enabled "Forced logoff during call" with a set timeout, forced logoff does not occur until this timeout expires.

#### Logon via a key

If a program key is configured for Mobility.



Press the "Mobility" program key.

or

#### Logon via the context menu

Mobile logon

Select and confirm the option shown in the idle display → page 29 context menu.

Mobility ID

You are prompted to enter your mobility ID.



Enter and confirm mobility ID – usually a phone number.

Enter password

You are prompted to enter the password.



Enter and confirm the user password.

The following mobility messages appear in the display:

- Validating
- Logging off elsewhere



At the same time, the graphic display on the busy remote phone shows "Forced logoff pending". After the set timeout, the active call is ended and remote logoff is performed.

- Registering
- Downloading user data

Once logon is complete, the "Mobility" program key LED lights up and the mobility icon appears in the graphic display .

## Step by Step

## OpenScope Voice functions

The OpenScope Voice supports a number of functions that you can activate and deactivate from your phone.



On multi-line telephones, the full scope of OpenScope Voice functions is only available for the primary line.

### Feature toggle key

You can pick a programmable sensor key and program it as a feature toggle key for activating the "make line busy" and "stop hunt" functions.

You can then use the programmable sensor key to activate or deactivate the relevant OpenScope Voice function on the server for this phone.

You can only program first-level programmable sensor keys because those linked to LEDs are used to display function status as either **on** (LED on) or **off** (LED off). The LED indicates the status of the function on the server and can therefore change without any of the programmable sensor keys being pressed.

#### Example:

Switching between "Line busy" and "Line free" (see also → page 148).

**Prerequisite:** Your administrator configured a programmable sensor key with the function "Busy" ("make line busy" for the hunt group) → page 72.



Press the programmable sensor key – the key lights up.



Press the illuminated programmable sensor key once again to release the line - the keys stops illuminating.

## Step by Step

## Making anonymous calls

Your administrator decides whether or not your caller ID (name and phone number) is displayed on a called party's station. **Anonymous** calling is when your data is not transmitted. The settings configured can be deactivated, however, for specific calls.



- If your caller ID is transmitted: your caller ID is displayed.
- If your caller ID is suppressed: "unknown" is displayed.

## Deactivating

If your administrator permanently activated **anonymous calling** for your phone, you can deactivate this setting as follows:



Lift the handset.



Enter the code (see the table of codes → page 156) to transmit the caller information.



You hear a confirmation tone.

## Activating

If your administrator activated caller ID transmission for your phone, you can deactivate this setting as follows:



Lift the handset.



Enter the code (see the table of codes → page 156) to suppress the caller ID.



Wait until you hear the confirmation tone.

Caller ID transfer is suppressed. "Private/Anonymous" appears on the called party's display instead of the caller ID.

## Step by Step

### Temporarily activating anonymous calling for the next call

If your administrator activated caller ID transmission for your phone, you can deactivate this setting for the next call as follows:



Lift the handset.



Enter the code (see the table of codes → page 156).



Wait until you hear the confirmation tone.



Dial the phone number of the party you want to contact.  
Caller ID transmission is reactivated after this call.

### Temporarily deactivating anonymous calling for the next call

If your administrator suppressed caller ID transmission for your phone, you can enable this setting for the next call as follows:



Lift the handset.



Enter the code (see the table of codes → page 156).



Wait until you hear the confirmation tone.



Dial the phone number of the party you want to contact.  
When you end this call, caller ID transmission is suppressed once again for the next call.

## Step by Step

## Creating a list for selective calls

### For call acceptance

You can create a list of the phone numbers from which you are willing to accept calls (also known as a selection list). Your administrator know how long this list may be in the OpenScape Voice used on site in your facility.

A connection is set up if a caller's phone number matches a number in the selection list. If there is a match:

- the caller receives a message that the party refuses to accept any calls with this number,
- or**
- the call is forwarded to an external phone number.

Contact your administrator for information on how your OpenScape Voice is configured on site.



Lift the handset.



Enter the code (see the table of codes → page 156).

Various announcements deliver the following information:

- the name of the feature (selective call acceptance)
- the current status (active or inactive)
- the current scope of the selection list.

These announcements are followed by verbal user prompts that let you:

- add entries to the selection list
- delete entries in the selection list
- check the selection list
- activate or deactivate the function.



## Step by Step

### For call rejection

As for selective call acceptance, you can create a selection list with the phone numbers of parties from whom you are not willing to accept calls. Your administrator knows how long this list may be in the OpenScape Voice used on site in your facility.

A call is not connected if the caller's phone number matches a number in the selection list; the caller is notified that the called party rejects calls from this number. If the caller's number is not in the selection list, the call is to you as usual.



Lift the handset.



Enter the code (see the table of codes → page 156).

Various announcements deliver the following information:

- the name of the feature (selective call rejection)
- the current status (active or inactive)
- the current scope of the selection list.

These announcements are followed by verbal user prompts that let you:

- add entries to the selection list
- delete entries in the selection list
- check the selection list
- activate or deactivate the function.

## Step by Step

### Anonymous calls

#### Rejecting

You can reject all calls from parties that activated a data protection feature (for example, caller ID suppression) to prevent their phone number from being transmitted. In this case, you are not informed that a call was rejected.



Lift the handset.



Enter the code (see the table of codes → page 156).

#### Accepting

You can also accept calls from parties that activated a data protection feature (for example, caller ID suppression) to prevent their phone number from being transmitted.



Lift the handset.



Enter the code (see the table of codes → page 156).

## Step by Step

### Using abbreviated dialing

Abbreviated dialing gives you access to a central list of frequently dialed phone numbers.

You can dial a specific phone number by simply entering a digit string. As these are three-digit numbers, you can store up to 1000 phone numbers. This list is stored centrally and managed by your administrator.



Lift the handset.



Enter the code (see the table of codes → page 156) followed by a number between 0 and 999 for the phone number you want to dial.

The number is automatically dialed.

### Call tracing

You can request automatic tracing of the last received internal call. This is particularly suitable for identifying malicious, irritating or troublesome calls.



Lift the handset.



Enter the code (see the table of codes → page 156). The phone number is determined. Ask your service personnel for the result.

## Step by Step

## Hunt group functions

To ensure optimum handling of specific calls, your telephone can be assigned to a pickup group → page 47 and/or a hunt group.

Your administrator can incorporate multiple telephones in a hunt group. If your telephone is assigned to a hunt group, OpenScape Voice forwards calls for the members of your group in accordance with specific rules defined by your administrator. Hunt groups are a simple solution for distributing calls to a group of telephones.

If you want another member of the group to pick up an incoming call, you can set your telephone to signal the busy status for your line to the other members of the hunt group. Hunt group calls will then no longer be forwarded to your telephone.

This feature can also be configured using the programmable feature toggle key → page 141.

## Making a line busy

This prevents this line being used for calls in a hunt group.

### Activating



Lift the handset.



Enter the code (see the table of codes → page 156).



Wait until you hear the confirmation tone.

### Deactivating

Make the line free once more for the hunt group.



Lift the handset.



Enter the code (see the table of codes → page 156).



Wait until you hear the confirmation tone.

## Step by Step

### Marking the last line in the hunt group chain

Sets the "stop hunt" line in the hunt group chain. The system will stop looking for a free line in the hunt group chain after it reaches this line.

#### Activating



Lift the handset.



Enter the code (see the table of codes → page 156).



Wait until you hear the confirmation tone.

#### Deactivating

Unmark the line as the end of the hunt group chain.



Lift the handset.



Enter the code (see the table of codes → page 156).



Wait until you hear the confirmation tone.

## Step by Step

## Reachability

You can make either serial calls or simultaneous calls on several sites. The features for this are

- Serial call
- Parallel call

**Prerequisite:** The service personnel has configured the respective feature for your main number in OpenScape Voice.

### Serial call

#### Managing number lists/activating serial call

Before the serial call number can be activated, a serial call list must be created. This can be prepared either by service personnel or you can create it yourself later. Up to six numbers can be entered in the list for sites on which incoming calls including your main number should be signaled sequentially. Each number can consist of up to 30 digits.



Lift the handset.

Enter the code for the edit mode (see code table → page 156).

The edit mode opens and you hear an announcement with the following information:

- Feature name
- Current status (active/inactive)
- Number of numbers currently on the serial call list

You are prompted to do one of the following:

- Activate/deactivate the feature (only if numbers are already entered in the list)
- Call up the numbers currently entered in the list.
- Add or delete numbers
- Repeat the options in edit mode

If the serial call list is still empty, you are prompted to enter numbers in the list. As soon as you have entered a valid number, the serial call can be activated.

If the serial call is activated, incoming calls are first routed to your phone. If you do not answer within the time-frame defined by the service personnel, the next destination phone rings for the configured period of time.

## Step by Step

The caller is informed that the call is being routed to another station. The connection is established with the first phone that accepts the call.

If the call is not answered by any phone, it is forwarded to the configured forwarding destination (on no reply) or to a "rejection announcement".

## Parallel call

### Managing number lists/activating parallel call

Before the parallel call feature can be activated, a parallel call list must be created. This can be prepared either by service personnel or you can create it yourself later. Up to six numbers can be entered in the list for sites on which incoming calls including your main number should be signaled sequentially. Each number can consist of up to 30 digits.



Lift the handset.



Enter the code for the edit mode (see code table → page 156).

The edit mode opens and you hear an announcement with the following information:

- Feature name
- Current status (active/inactive)
- Number of numbers currently on the parallel call list

You are prompted to do one of the following:

- Activate/deactivate the feature (only if numbers are already entered in the list)
- Call up the numbers currently entered in the list.
- Add or delete numbers
- Repeat the options in edit mode

If the parallel call list is still empty, you are prompted to enter numbers in the list. As soon as you have entered a valid number, the parallel call can be activated.

If the parallel call is activated, incoming calls are routed to your phone and all other destination phones in the parallel call list. The connection is established with the first phone that accepts the call.

If the call is not answered by any phone, it is forwarded to the configured forwarding destination (on no reply) or to a "rejection announcement".

## Step by Step

### Activating/deactivating parallel call via code

You can activate/deactivate the parallel call without having to change to edit mode.

**Prerequisite:** You have already entered numbers in the parallel call list.



Lift the handset.



Enter the code to activate or deactivate the parallel call (see code table → page 156).



## Step by Step

## Parking a call

If you have answered a call for a colleague and cannot forward it to him, you can park the call.

### Park a call



You are conducting the call. Let the other party know, e.g. that you are trying to connect him.



Enter the code for parking followed by a line number (see code table → page 156).

You receive a confirmation tone. The caller hears a waiting melody.



Replace the handset

Tell your colleague that a call for him is parked and give him the line number.

### Unparking

To unpark the call, your colleague must proceed as follows:



Lift the handset.



Enter the unparking code (see code table → page 156). He is prompted to enter a line number.



Enter the specified line number.



Your colleague is now connected with the waiting caller.

## Step by Step

## Silent Monitoring

If this function has been configured by service personnel and enabled for the destination phone, you can join an active call of an internal station and listen in unnoticed (muted) or with the knowledge of the target station (active).

### Active silent monitoring

Station A and B are on a call. You want to listen to the call but so that Station B does not notice but so that you can still talk to Station A.

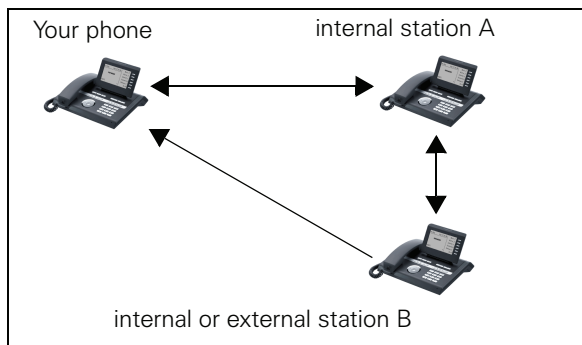

- You can hear and talk to station A.
- You can hear station B but cannot talk to him because he cannot hear you.
- Station A and B can hear and speak to each other.



Lift the handset.



Enter the code for active silent monitoring and the destination number (see code table → page 156). You are connected to the call and can listen. If necessary notify station A.



End the silent monitoring unnoticed by replacing the handset.

## Step by Step

**Muted silent monitoring**

Station A and B are on a call. You want to monitor a call but so that neither station notices.

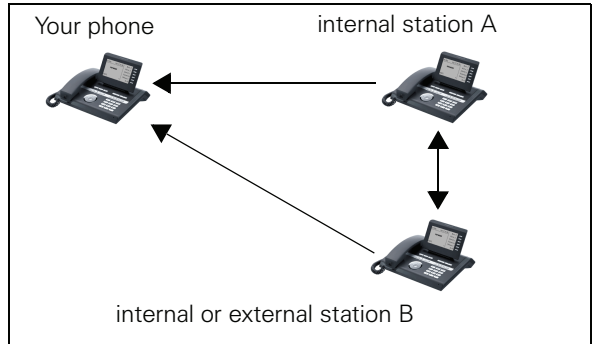

- You can hear station A but cannot talk to him because he cannot hear you
- You can hear station B but cannot talk to him because he cannot hear you.
- Station A and B can hear and speak to each other



Lift the handset.



Enter the code for active silent monitoring and the destination number (see code table → page 156). You are connected to the call and can listen.



End the silent monitoring unnoticed by replacing the handset.

## Table of codes for OpenScape Voice functions

Ask your administrator to enter the latest codes in the following table. Print this page as an overview.

Function	Code	Description
Making anonymous calls off		→ page 142
Making anonymous calls on		→ page 142
Making anonymous calls temporarily on		→ page 143
Making anonymous calls temporarily off		→ page 143
List for selective call acceptance		→ page 144
List for selective call rejection		→ page 145
Rejecting anonymous calls		→ page 146
Accepting anonymous calls		→ page 146
Using abbreviated dialing		→ page 147
Call tracing		→ page 147
Making a line busy on		→ page 148
Making a line busy off		→ page 148
End of hunt group chain on		→ page 149
End of hunt group chain off		→ page 149
Edit mode for serial call		→ page 150
Edit mode for parallel call		→ page 151
Activating a parallel call		→ page 152
Deactivating a parallel call		→ page 152
Parking a call		→ page 153
Unparking a call		→ page 153
Active silent monitoring		→ page 154
Muted silent monitoring		→ page 155

## Step by Step

## Individual phone configuration

### Display

#### Adjusting the display to a comfortable reading angle

You can swivel the display unit. Adjust the display unit so that you can clearly read the screen.

#### Setting contrast

The display has six contrast levels that you can set according to your light conditions.



You can also configure this setting via the Web interface → page 176.



Press the key shown.

Settings

Select and confirm the option shown.

User

Select and confirm the option shown.

if nec.



Enter and confirm the User password.

Phone

Select and confirm the option shown.

Display

Select and confirm the option shown.

Contrast

Select and confirm the option shown.



Set and confirm the contrast.

Save & Exit

Confirm the option shown.

### Background lighting

Your service personnel can set a time of between two and eight hours defining how long the phone should be idle before display backlighting deactivates completely.

## Step by Step

### Contrast for the OpenStage Key Module

If an OpenStage Key Module is connected to your OpenStage 40, you can set contrast for it.



Press the key shown.

Settings

Select and confirm the option shown.

User

Select and confirm the option shown.

**if nec.** 

Enter and confirm the User password.

Phone

Select and confirm the option shown.

Display

Select and confirm the option shown.

Key mod. contrast

Select and confirm the option shown.



Set and confirm the contrast.

Save & Exit

Confirm the option shown.

## Step by Step

## Date and time

You can set the date and time display here if necessary.



You can also configure this setting via the Web interface  
→ page 176.



You must set the date and time manually if your phone is not connected to an (S)NTP server.

## Setting the time



Press the key shown.

Settings

Select and confirm the option shown.

User

Select and confirm the option shown.

if nec.



Enter and confirm the User password.

Date and time

Select and confirm the option shown.

Time

Select and confirm the option shown.



Enter and confirm the time.

Save & Exit

Confirm the option shown.

## Setting the date



Press the key shown.

Settings

Select and confirm the option shown.

User

Select and confirm the option shown.

if nec.



Enter and confirm the User password.

Date and time

Select and confirm the option shown.

Date

Select and confirm the option shown.

### Step by Step



Enter and confirm the date.

Save & Exit

Confirm the option shown.

### Setting daylight saving time

**Prerequisite:** **Auto DST** is deactivated → page 161.



You can also configure this setting via the Web interface → page 176.



Press the key shown.

Settings

Select and confirm the option shown.

User

Select and confirm the option shown.

if nec.

Enter and confirm the User password.

Date and time

Select and confirm the option shown.

Daylight saving

Select and confirm the option shown.

Yes

Select and confirm the option shown in the context menu.

Save & Exit

Confirm the option shown.

### Setting the difference between daylight saving and standard time

**Prerequisite:** **Auto DST** is deactivated → page 161.

Enter the difference to be used for daylight saving time.



You can also configure this setting via the Web interface → page 176.



Press the key shown.

Settings

Select and confirm the option shown.

User

Select and confirm the option shown.

if nec.

Enter and confirm the User password.



## Step by Step

Date and time

Select and confirm the option shown.

Difference (mins)

Select and confirm the option shown.



Enter and confirm the difference between daylight and standard time in minutes.

Save & Exit

Confirm the option shown.

## Automatic daylight saving time

The **Auto DST** setting (automatic time-update) is provided for information purposes and can only be changed by your service personnel.



You can also access this information via the Web interface → page 176.



Press the key shown.

Settings

Select and confirm the option shown.

User

Select and confirm the option shown.

if nec.



Enter and confirm the user password.

Date and time?

Select and confirm the option shown.

Daylight saving time must be manually set if a **No** is entered for **Auto DST** → page 160.

### Step by Step



### Time display format

You can also configure this setting via the Web interface → page 176.



Press the key shown.

Settings

Select and confirm the option shown.

User

Select and confirm the option shown.

**if nec.**

Enter and confirm the User password.

Locality

Select and confirm the option shown.

Time format

Select and confirm the option shown.

24 hour

Select and confirm the time format (12- or 24-hour display) in the context menu.

Save & Exit

Confirm the option shown.



### Date display format

You can also configure this setting via the Web interface → page 176.



Press the key shown.

Settings

Select and confirm the option shown.

User

Select and confirm the option shown.

**if nec.**

Enter and confirm the User password.

Locality

Select and confirm the option shown.

Date format

Select and confirm the option shown.

dd/mm/yyyy

Select and confirm the format you want.

Save & Exit

Confirm the option shown.

## Step by Step

## Audio

## Volumes

Use this selection to set the following volumes:

- Loudspeaker
- Ringer
- Handset
- Headset
- Handsfree
- Rollover

Example: **Handset**



Settings

Press the key shown.

Select and confirm the option shown.

User

Select and confirm the option shown.

if nec.



Enter and confirm the User password.

Audio

Select and confirm the option shown.

Volumes

Select and confirm the option shown.

Handset

Select and confirm the volume you want to adjust (for example, "Handset").



Set and confirm the volume.

An acoustic sample of the current volume is output via audio feedback when you adjust the volume.

Save & Exit

Confirm the option shown.

## Step by Step

### Settings

#### Room character

To ensure that the other party can hear you properly in speakerphone mode, you can adjust the phone to the room acoustics by choosing one of the following room character conditions: "Normal", "Echoing", "Muffled" .



You can also configure this setting via the Web interface → page 176.



Press the key shown.

Settings

Select and confirm the option shown.

User

Select and confirm the option shown.

if nec.

Enter and confirm the User password.

Audio

Select and confirm the option shown.

Settings

Select and confirm the option shown.

Room character

Select and confirm the option shown.

Normal

Select and confirm the room character in the context menu (for example, "Normal") ( → page 178).

Save & Exit

Confirm the option shown.

#### Ringtone

If your service personnel has loaded suitable files to the phone, you can select a realtone file in \*.mp3 or \*.wav format for the ringer tone. If no individual audio files are available the "pattern" ringtone is preset.



You can also configure this setting via the Web interface → page 176.



Press the key shown.

Settings

Select and confirm the option shown.

User

Select and confirm the option shown.

## Step by Step

if nec.



Enter and confirm the User password.

Audio

Select and confirm the option shown.

Settings

Select and confirm the option shown.

Ringer melody

Select and confirm the option shown.

ABC.wav

Select and confirm the required ringer file<sup>[1]</sup> or "pattern."  
You will immediately hear the associated ringer melody.  
Confirm current ringtone file.

Save &amp; Exit

Confirm the selected ringtone to use it or try a different ringtone.

**Pattern melody**

You can also configure this setting via the Web interface  
→ page 176.

**Prerequisite:** You have chosen the "pattern" ringtone,  
see → page 164.



Press the key shown.

Settings

Select and confirm the option shown.

User

Select and confirm the option shown.

evtl.



Enter and confirm the User password.

Audio

Select and confirm the option shown.

Settings

Select and confirm the option shown.

Ringer tone sequence

Select and confirm the option shown.

4

Select the required pattern melody<sup>[1]</sup> between 1 and 8  
(e. g. **4**). You will immediately hear the corresponding  
Ringer melody. Confirm the selected Ringer melody.

Save &amp; Exit

Select and confirm the option shown.

1. The phone displays the current setting.

### Step by Step



#### Pattern sequence

You can also configure this setting via the Web interface → page 176.

**Prerequisite:** You have chosen the "pattern" ringtone, see → page 164.



Press the key shown.

Settings

Select and confirm the option shown.

User

Select and confirm the option shown.

Audio

Select and confirm the option shown.

Settings?

Select and confirm the option shown.

Ringer tone sequence

Select and confirm the option shown.

2

Select your desired Ringer tone sequence between 1 and 3 (e. g. **2**) You immediately hear the set Ringer melody with the chosen Ringer tone sequence. Confirm the selected setting.

Save & Exit

Select the option shown and confirm twice.

## Step by Step

**Country setting for speakerphone mode**

Enter the country setting you prefer for speakerphone mode here (see → page 44).



You can also configure this setting via the Web interface → page 176.



Press the key shown.

Settings

Select and confirm the option shown.

User

Select and confirm the option shown.

**if nec.**



Enter and confirm the User password.

Audio

Select and confirm the option shown.

Settings

Select and confirm the option shown.

Open listening

Select and confirm the option shown.

Standard mode

Select and confirm the setting you want in the context menu ("Standard mode" or "US mode").

Save & Exit

Confirm the option shown.

### Step by Step

#### Setting headset port use

Here you set whether you are using a wired or cordless DECT headset.



You can also configure this setting via the Web interface → page 176.



Press the key shown.

Settings

Select and confirm the option shown.

User

Confirm the option shown.

**if nec.**

Enter and confirm the user password.

Audio

Select and confirm the option shown.

Settings

Select and confirm the option shown.

Kopfhöreranschluss

Select the option shown.

Verkabelter Kopfhörer?

From the following setting<sup>1</sup> select and confirm the option shown in the context menu.

- Verkabelter Kopfhörer
- Schnurloser Kopfhörer
- Konferenzgerät

Save & Exit

Select and confirm the option shown.

1. The phone displays the current setting.



## Step by Step

## Nonsecure voice communication tone and message

Use this option to activate an alerting tone that you hear when a secure voice connection with the party you are currently talking to ceases to be secure. The message "Nonsecure connection" also appears.

**Prerequisite:** Secure connection setup is the preference set by your administrator.



You can also configure this setting via the Web interface → page 176.



Press the key shown.

Settings

Select and confirm the option shown.

User

Select and confirm the option shown.

if nec.



Enter and confirm the User password.

Configuration

Select and confirm the option shown.

Connected calls

Select and confirm the option shown.

Secure call alert

Select and confirm the option shown.

Yes

Select and confirm the option shown in the context menu.

Save & Exit

Select and confirm the option shown.

## Step by Step

# Setting the language and country

## Selecting a language



You can also configure this setting via the Web interface  
→ page 176.



Press the key shown.

Settings

Select and confirm the option shown.

User

Select and confirm the option shown.

**if nec.**

Enter and confirm the User password.

Locality?

Select and confirm the option shown.

Speech?

Select and confirm the option shown.

Deutsch

Select and confirm the language<sup>[1]</sup> in the context menu.

Save & Exit

Confirm the option shown.

1. The phone displays the current setting.

**Step by Step****You may choose from the following languages:**

1. Bahasa Indonesia
2. Bahasa Malaysia
3. Brasileiro
4. Català
5. Čeština
6. Dansk
7. Deutsch
8. English
9. English(US)
10. Español
11. Français
12. Hrvatski
13. Italiano
14. Latviešu Valoda
15. Lietuvių Kalba
16. Magyar
17. Nederlands
18. Norsk
19. Polski
20. Português
21. Română
22. Slovenčina
23. Slovenski Jezik
24. Srpski Jezik
25. Suomi
26. Svenska
27. Tiếng Việt
28. Türkçe
29. Ελληνικά
30. Български
31. Македонски Јазик
32. Русски
33. Српски Језик
34. 中文
35. 中文

## Step by Step

### Country-specific setting

Adapt your phone settings to suit the country-specific conditions (for example, transmission parameters).



You can also configure this setting via the Web interface → page 176.



Press the key shown.

Settings

Select and confirm the option shown.

User

Select and confirm the option shown.

if nec.

Enter and confirm the User password.

Locality

Select and confirm the option shown.

Country

Select and confirm the option shown.

Germany

Select and confirm the country <sup>[1]</sup> in the context menu.

Save & Exit

Confirm the option shown.

#### You may choose from the following countries:

- |                    |                        |
|--------------------|------------------------|
| 1. Argentina       | 20. Luxembourg         |
| 2. Australia       | 21. Mexico             |
| 3. Austria         | 22. Netherlands        |
| 4. Belgium         | 23. New Zealand        |
| 5. Brazil          | 24. Norway             |
| 6. Canada          | 25. Poland             |
| 7. China           | 26. Portugal           |
| 8. Chile           | 27. Russian Federation |
| 9. Croatia         | 28. Singapore          |
| 10. Czech Republic | 29. Slovakia           |
| 11. Denmark        | 30. South Africa       |
| 12. Finland        | 31. Spain              |
| 13. France         | 32. Sweden             |
| 14. Germany        | 33. Switzerland        |
| 15. Hungary        | 34. Thailand           |
| 16. India          | 35. United Kingdom     |
| 17. Ireland        | 36. United States      |
| 18. Italy          | 37. Vietnam            |
| 19. Japan          |                        |

1. The phone displays the current setting.

## Step by Step

## Context menu

After a connection is set up, a context menu appears with dependent functions. You can activate/deactivate the automatic display and can also set how long the context menu should be displayed.



You can also configure this setting via the Web interface → page 176.



Press the key shown.

Select and confirm the option shown.

Select and confirm the option shown.

if nec.



Enter and confirm the User password.

Select and confirm the option shown.

Select and confirm the option shown.

### Activating/deactivating automatic menu display

Select and confirm the option shown.

In the context menu select and confirm to activate automatic menu display.

Select and confirm the option shown.

### Setting the display time

Select and confirm the option shown.

In the context menu select and confirm a value from the following options:

- 5
- 10
- 20
- 30
- 60
- 120
- Unlimited display

Select and confirm the option shown.

## Step by Step

### Network information

This information overview in the user area of the service menu provides you with information about the IP address or name of the phone and the HTML address of the web-interface. It also provides real-time data about the network activity of the phone.



Press the key shown.

Settings

Select and confirm the option shown.

User

Select and confirm the option shown.

if nec.

Enter and confirm the user password.

Network information

Select and confirm for the following overview:

The screenshot shows a menu titled "Network information" with the following content:

- Options: Exit →
- IP address: 192.168.1.9
- [WBM URL: http://192.168.1.
- DNS domain: opera.local
- LAN RX: [Progress bar]
- LAN TX: [Progress bar]
- PC RX: [Progress bar]
- PC TX: [Progress bar]
- LAN autonegotiated: Yes
- LAN information: 100 Mbps full
- PC autonegotiated: Yes
- PC information: Link down

**IP Address:** Displays the IP address or name which was assigned to the phone.

**WBM URL:** HTTP address of the Web interface. This address is specified in the Internet browser and is used to call the Web interface of the phone in the browser.

**DNS domain:** The administrator can also assign the phone to the IP address of a DNS domain (for example, http://my-openStage.phone/).

## Step by Step

## Resetting user data

The following user-specific settings changed via the phone menu or the Web interface can be reset to factory settings.

- Display contrast
- Language setting
- Audio settings
  - Volumes
  - Settings
- Call lists
  - All entries are deleted.
- Programmable keys
  - All personalized programming is deleted (see also → page 75).

**Important:** All data is reset **without** a warning tone.

### Initiating the reset



Press the key shown.

Settings

Select and confirm the option shown.

User

Confirm the option shown.

if nec. 

Enter and confirm the user password.

Reset

Select and confirm the option shown.

All user data...

Select and confirm "Reset all user data." The user data is reset to factory settings.

## Web interface (WBM)

### General

You can configure a number of settings for your phone via the Web interface. Communication is via a secure HTTPS connection.

### Calling up the Web interface

---

 For more information on the IP address, the Web interface address, and how to connect the telephone to the network, refer to the section entitled "Network information" → page 174.

---

To call up the interface, open a Web browser and enter the following:

**http://[IP address of the phone]:[port]** or

**https://[IP address of the phone]**

[IP address of the phone] is the IP address of your phone.

**https://[Name of the phone]**

[Name of the phone] which was assigned by service personnel.

[Port] is the port address of the phone's HTTP server and must be 8085.

---

 You might receive a certificate notification from the browser. Follow the instructions to download the certificate.

You will be prompted to configure a user password the first time you call up the Web interface → page 132. You must log on with this password in future every time you want to open the User Pages.

---

### Administrator Pages

This area lets you configure settings for administering your phone and the network environment. Access to the Administrator Pages is protected by the admin password. For more information, contact your administrator or refer to the administration manual.



## User pages

The Web interface homepage opens once you have entered and confirmed the phone's IP address:

The screenshot displays the Siemens Web interface (WBM) homepage. At the top, the Siemens logo is on the left, and the phone's information is on the right: Phone number 3333, Phone IP address 192.168.1.245, and DNS name 3333. Below this is a navigation bar with 'User Pages' and 'Administrator Pages' tabs, and a 'Logout' button. The main content area is divided into three sections: 'User menu', 'User selection', and 'Phone information'. The 'User menu' is a vertical list of options including 'User login', 'Date and Time', 'Audio', 'Configuration', 'Outgoing calls', 'Incoming calls', 'Deflecting', 'Forwarding', 'Handling', 'CTI calls', 'Connected calls', 'Context menu', 'Keyset', 'BLF', 'Phone', 'Locality', 'Authentication', and 'Phonebook'. The 'User selection' section shows a 'User login' form with a text input field for 'Enter User password', 'Login' and 'Reset' buttons, and a footer note: 'Manufactured by Siemens Enterprise Communications GmbH & Co. KG under Trademark License of Siemens AG'. The 'Phone information' section is currently empty. Labels with arrows point to various elements: 'User menu' points to the left sidebar, 'User selection' points to the 'User login' form, and 'Phone information' points to the top right area. A 'Highlighted entry (current page)' label points to the 'User login' menu entry, and a 'Menu heading' label points to the 'User login' menu heading. A 'Menu entry' label points to the 'User login' menu entry.

1. Click a menu heading to display the individual menu entries. Click the menu heading again to close the menu.
2. Click a menu entry to open the corresponding form.
3. Make the desired changes.
4. Click the corresponding button to save or discard your changes.

### Button functions

- "Login": Log on to the phone after you have entered the user password
- "Submit": Apply changes
- "Reset": Reset original values
- "Refresh": Update the values.
- "Logout": Log off the phone





### User menu

All settings that you can make via the Web interface's user menu can also be made via the phone's user menu





#### User Pages

User login  → page 132

















#### Date and time

- Local time  → page 159
- Local date (day, month, year)  → page 159
- Allow daylight saving  → page 160
- Difference (minutes)  → page 160
- Auto time change  → page 161



























#### Audio

- Ringer melody ( → page 165)
- Ringer tone sequence ( → page 166)
- Ring file ( → page 164)
- Room character ( → page 164)
- Open listening ( → page 167)

#### Configuration





- Outgoing calls
  - Autodial delay (seconds)  → page 94
  - Allow callback: busy  → page 66
  - Allow callback: no reply  → page 66
  - Allow busy when dialling  → page 96
  - Allow transfer on ring  → page 89
  - Allow immediate dialling  → page 51
- **Incoming calls**
  - Deflecting
    - Allow deflection ( → page 77)
    - Default deflect destination  → page 77
    - Deflect to DSS  → page 77
  - Forwarding
  - Settings
    - Forwarding Favourites Destination 1 to Destination 5  → page 77
    - Forward all calls allowed  → page 61
    - to  → page 60
    - Forward on busy allowed  → page 61
    - to  → page 60
    - Forward on no reply allowed  → page 61
    - to  → page 60
    - No reply delay (seconds)<sup>1</sup>  → page 60

[1] Only if "Server features" was deactivated by your administrator





- Alerts
  - Visual alerts  → page 79
  - Audible alerts  → page 79
  - Forwarding party  → page 63
- Handling
  - Allow call waiting  → page 85
  - Allow DND  → page 131
  - Allow busy when dialling  → page 96
- CTI-Calls
  - Allow auto-answer  → page 90
  - Allow beep on auto-answer  → page 90
  - Allow beep on auto-reconnect  → page 91
- Connected calls
  - Allow call transfer  → page 88
  - Allow call joining  → page 57
  - Allow exit conference  → page 99
  - Allow hold reminder  → page 81
  - Hold reminder delay (minutes)  → page 81
  - Allow music on hold  → page 82
  - Allow conferences  → page 98
  - Allow secure call alert  → page 169
  - Toggle associate  → page 86
- Context menu
  - Auto Show menu  → page 173
  - Auto hide time (sec.)  → page 173
- **Keyset**
  - Lines
    - Ring delay (seconds)  → page 125
    - Allow in overview  → page 124
    - Address<sup>[1]</sup>
    - Primary line<sup>[1]</sup>
    - Ring on/off<sup>[1]</sup>
    - Selection order<sup>[1]</sup>
    - Hot/Warmline<sup>[1]</sup>
    - Hot warm destination  → page 114
  - Overview
    - Use FPK order  → page 126
    - Add all lines  → page 126
    - Reordering directions: Move down, Move to bottom, Move to top, Move up  → page 126
- BLF
  - Busy Lamp Field: **not** for OpenScape Voice

[1] Information - read only

## Phone

- Display
  - Contrast  → page 157
  - Key module contrast  → page 158
- Program keys
  - Normal
    - Edit.  → page 69.
  - Shifted
    - Edit.  → page 69.
- Key Module 1 (if available such as Program keys)
- Key Module 2 (if available such as Program keys)

## Locality

- Country  → page 172
- Language  → page 170
- Date format  → page 162
- Time format  → page 162

## Authentication

- Old password
- New password  → page 132
- Confirm password

## Phone book

- Contact list  → page 102
- New contact  → page 102
- Delete all contacts  → page 103

## Fixing problems

### Caring for your telephone

- Never allow the telephone to come into contact with coloring, oily or aggressive agents.
- Always use a damp or antistatic cloth to clean the telephone. Never use a dry cloth.
- If the telephone is very dirty, clean it with a diluted neutral cleaner containing surfactants, such as a dish detergent. Afterwards remove all traces of the cleaner with a damp cloth (using water only).
- Never use aggressive or alcohol-based cleansers on plastic parts. The use of scouring agents is also forbidden.

### Troubleshooting

#### **Pressed key does not respond:**

If the telephone is locked redial keys cannot be used. This also applies when emergency numbers or predefined numbers from the dial plan are stored on them.

Check whether your telephone is locked ("Phone locked" appears on the screen. To unlock enter the PIN."). If the phone is locked, unlock it.

#### **The phone does not ring on call:**

Check whether the ringtone is deactivated (see icon in the status bar on the display → page 26). If it is deactivated, activate the ringtone

#### **The displayed time is incorrect:**

The time is corrected automatically over night after 24 hours at the latest.

#### **You cannot dial a number:**

Check whether your telephone is locked ("Phone locked: Enter Password" appears on the screen). If the phone is locked, unlock it.

#### **To correct any other problems:**

First contact the relevant administrator. If the administrator are unable to correct the problem, contact Customer Service.

### Contact partner in the case of problems

Contact your administrator if a fault persists for more than five minutes, for example.

### Labeling keys

The following options are available for labeling keys of the OpenStage Key Module 15 (→ page 18) with the functions or numbers assigned to them:

#### Labeling

- By hand:  
Labeling strips are supplied with your OpenStage Key Module 15. Note the function or name in the white field on the strip and insert the strip on your OpenStage Key Module 15.
- With a computer via the Internet:  
You can find the "online labeling tool" together with the user interface at [http://wiki.siemens-enterprise.com/index.php/Key\\_Labeling\\_Tool](http://wiki.siemens-enterprise.com/index.php/Key_Labeling_Tool)
- Select the appropriate key labeling tool in your language. You can use the tool online via the browser or you can download it for local use.

## Local user menu

### Opening the user menu on the phone

Press the  key to open the telephone menu.

On the **Settings** menu, open the **User** menu. You are prompted to enter the User password → page 132. Confirm this with **OK**. The options of the user menu are available.

### User menu display

The majority of settings that can be made via the user menu on the phone, can also be made via the web interface → page 176.







Changes are usually confirmed using the **Save & exit** option or discarded using the **Exit (no save)** option. You can exit the current menu level using the left key of the navigator (→ page 20).

#### **User**

##### **Date and time?**

- Options: Save & exit
  - Exit (no save) → page 159
- Time: hh:mm → page 159
- Date: DD.MM.YYYY → page 160
- Daylight saving: Yes
  - Yes
  - No
- Difference (mins): mm → page 160
- Auto DST: Yes/No → page 161

#### **Audio?**

- Volumes?
  - Options: Save & exit
    - Exit (no save)
  - Loudspeaker:  → page 163
  - Ringer:  → page 163
  - Handset:  → page 163
  - Headset:  → page 163
  - Handsfree:  → page 163
  - Rollover:  → page 163
- Settings?
  - Options: Save & exit
    - Exit (no save)
  - Ringtone: Ring file → page 164
    - Pattern
    - Ringer1.wav

- Ringer2.wav
- Ringer3.wav
- Ringer4.wav
- Ringer5.wav
- Ringer6.wav
- Ringer melody: 2 → page 165
  - 1
  - 2
  - 3
  - 4
  - 5
  - 6
  - 7
  - 8
- Ringer tone sequence: 1 → page 166
  - 1
  - 2
  - 3
- Room character: Normal → page 164
  - Normal
  - Echoing
  - Muffled
- Open listening: Standard mode → page 167
  - Standard mode
  - US mode
- Headset socket: Cordless headset → page 168
  - Wired headset
  - Cordless headset
  - Conference unit

## Configuration?

### – Outgoing calls?

- Options: Save & exit
- Exit (no save)
- Autodial delay: 6 → page 94
  - 1
  - 2
  - 3
  - 4
  - 5
  - 6
  - 7
  - 8
  - 9
- Callback: busy: Yes → page 66
  - Yes
  - No
- Callback: no reply: Yes → page 66



- Yes
- No
- Busy when dialling: Yes → page 96
  - Yes
  - No
- Transfer on ring: Yes → page 89
  - Yes
  - No
- Immediate dialling: Yes → page 51
  - Yes
  - No
- Incoming calls?**
  - Deflecting?
    - Options: Save & exit
      - Exit (no save)
    - Allow deflection: Yes → page 77
      - Yes
      - No
    - Default destination: → page 77
    - Deflect to DSS: Yes/No<sup>[1]</sup> → page 77
  - Forwarding?
    - Settings?
      - Options: Save & exit
        - Exit (no save)
      - All calls: Off → page 59
        - On
        - Off
      - Destination: Destination 1 to Destination 5
        - Edit favourites
        - Options: Save & exit
          - Exit (no save)
          - Destination 1
          - Destination 2
          - Destination 3
          - Destination 4
          - Destination 5
      - Busy: Off → page 59
        - On
        - Off
      - Destination: Destination 1 to Destination 5
        - Edit favourites?
        - Options: Save & exit
          - Exit (no save)
          - Destination 1
          - Destination 2
          - Destination 3

[1]. Information - read only

- Destination 4
  - Destination 5
- No reply: Off → page 59
  - On
  - Off
- Destination: Destination 1 to Destination 5
  - Edit favourites?
  - Options: Save & exit
    - Exit (no save)
    - Destination 1
    - Destination 2
    - Destination 3
    - Destination 4
    - Destination 5
  - Duration: 16
- Alerts
  - Options: Save & exit
    - Exit (no save)
  - Visual alerts: No → page 79
    - Yes
    - No
  - Audible alerts: No → page 79
    - Yes
    - No
  - Forwarding party: Display last → page 79
    - Display first
    - Display last
- Handling
  - Options: Save & exit
    - Exit (no save)
  - Allow call waiting: Yes → page 85
    - Yes
    - No
  - Allow DND: Yes → page 131
    - Yes
    - No
  - Busy when dialling: Yes → page 96
    - Yes
    - No
- CTI-Calls?
  - Options: Save & exit
    - Exit (no save)
  - AutoAnswer: Yes → page 90
    - Yes
    - No
  - AutoAnswer beep: Yes → page 90
    - Yes

- No
- AutoReconnect beep: Yes → page 91
- Yes
- No
- Connected calls?**
- Options: Save & exit
- Exit (no save)
- Allow call transfer: Yes → page 88
- No?
- Return?
- Allow call joining: Yes → page 57
- Yes
- No
- Allow exit conf: Yes → page 99
- Yes
- No
- Allow hold rem.: Yes → page 81
- Yes
- No
- Hold rem. delay: 8 → page 81
- 3?
- 4?
- 5?
- 6?
- 7?
- 8?
- 9?
- 10?
- 11?
- 12?
- 13?
- 14?
- 15?
- Music on hold: Yes → page 82
- Yes
- No
- Allow conferences: Yes → page 98
- Yes
- No
- Secure call alert: Yes → page 169
- Yes
- No
- Toggle associate: Yes → page 86
- Yes
- No
- Context menu**
- Automatic display menu Yes → page 173

- Yes
- No
- Display time 20 → page 173
  - 5
  - 10
  - 20
  - 30
  - 60
  - 120
  - Unlimited no.

- **⊕ Keyset?**

- Lines?
  - Line (one of **eight** possible)
    - Options: Save & exit
      - Exit (no save)
    - Ring delay: 0 → page 125
    - Allow in overview: Yes → page 124
      - Yes
      - No
    - Hot warm action<sup>[1]</sup>: No action
    - Hot warm dest: nnnn → page 114
    - Address<sup>[1]</sup>: nnnn
    - Ring on/off<sup>[1]</sup>: On
    - Selection order<sup>[1]</sup>: 1
  - Overview? → page 126
    - Line (up to **eight** lines)
      - Move down
      - Move to bottom
      - Use FPK order
      - Add all lines
    - Save
    - Do not save

- **BLF?**

- Busy Lamp Field: **not** for OpenScope Voice
- Return?

**⊕ Phone?**

- Display?
  - Options: Save & exit
    - Exit (no save)
  - Contrast:  → page 157
  - Key mod. contrast:  → page 158
- Program keys
  - Press the key to be programmed*
  - Options: Save & exit
    - Exit (no save)
  - Normal: Unallocated → page 69

[1]. Information - read only

- Unallocated
- *Further functions, see* → page 191
- Label: *predefined or customized*
- Settings: *function-dependent*
- Shifted: Unallocated → page 69
- Unallocated
- *Further functions, see* → page 192
- Label: *predefined or customized*
- Settings: *function-dependent*
- Key Module 1 (if available such as Program keys)





### Locality?

- Options: Save & exit
- Exit (no save)
- Country: DE → page 172
- DE?
- *Further countries, see* → page 172
- Language: Deutsch → page 170
- Deutsch
- *Further languages, see* → page 171
- Date format: dd/mm/yyy → page 162
- dd/mm/yyy
- yyyy/mm/dd
- mm/dd/yyyy
- Time format: 24 hour → page 162
- 24 hour
- 12 Hour (AM/PM)

### Security?

- Options: Save & exit
- Exit (no save)
- User password: \*\*\*\*\* → page 132
- Confirm password:

### Network information?

- Options: Exit
- Phone address: → page 174
- Web address:
- IP address:
- LAN RX: 
- LAN TX: 
- PC RX: 
- PC TX: 
- LAN autonegotiated: Yes
- LAN information: 10 Mbps full duplex
- PC autonegotiated: Yes
- PC information: Link down

**Reset?**

- Options: Cancel
- Cancel
- Reset all user data → page 175
- Reset selected user data → page 75
- Function key data: No? → page 75
- Yes
- No

## Key functions

### Normal

You can program the following functions on the Normal of the function keys:

- Selected dialling
- Repeat dialling
- Forward all calls
- Forward no reply
- Forward busy
- Mute
- Ringer off
- Hold
- Alternate
- Blind transfer call
- Transfer call
- Deflecting
- Shift
- Conference
- Headset
- Do not disturb
- Group pickup
- Repertory dial
- Feature toggle
- Mobility
- Directed pickup
- Callback
- Cancel callbacks
- Consultation
- Call Waiting toggle
- Immediate ring
- PreView
- Start application
- Built in fwd
- Opening the phonebook

### Shifted

You can program the following functions on the Shifted of the function keys:

- Selected dialling
- Repeat dialling
- Alternate
- Blind transfer call
- Transfer call
- Deflecting
- Conference
- Repertory dial
- Release
- Callback
- Cancel callbacks
- Consultation
- Start application



# Index

## A

Accepting calls	
multi-line .....	109
Administration .....	38
Audio	
room character .....	164
volume .....	163
Audio controls .....	19
Audio keys .....	19
Autodial delay .....	94
Auto-headset .....	41

## B

Background lighting .....	157
Busy override .....	115

## C

Call	
accepting .....	40
deflecting .....	76
ending .....	46
forwarding .....	58
Hold .....	80
incoming .....	39
rejecting .....	78
transferring .....	87
Call forwarding chain .....	63
Call forwarding information .....	111
Call lists .....	35, 105
Call log .....	35
Call settings	
CTI calls .....	164
multi-line .....	124
Call waiting .....	83
Callback .....	64
CE marking .....	2
Conference .....	97
Connection options .....	15
Consultation .....	54
Consultation call from second call .....	83
Context .....	51
Context menus .....	27

## D

Date .....	159
Dial plan .....	94
Display icons .....	26
Display settings	
contrast .....	157
Do not disturb .....	130
DSS call	
call deflection .....	118
DSS key	
consultation .....	116
indirect pickup .....	117
reject call .....	117
During calls	
multi-line .....	112

## E

Executive-secretary .....	119
---------------------------	-----

## F

Forced logoff .....	140
Forwarding primary line .....	111
Freiprogrammierbare Sensortaste .....	68
Function keys .....	19

## G

General information .....	11
Graphic display .....	26
call lists .....	36
icons indicating call status .....	29
voicemail .....	34
Graphic display settings	
contrast .....	157
Group call .....	47

## H

Headset .....	76
answering call automatically .....	41
Hot line .....	52
for lines .....	114

- I**
- Icons ..... 26
  - Immediate dialing ..... 51, 94
  - Important information ..... 3
  - Incoming calls
    - multi-line ..... 109
- K**
- Key module contrast ..... 158
  - Key modules ..... 17
  - Keypad ..... 24
- L**
- Language setting ..... 170
    - country setting ..... 172
    - language for user prompts ..... 170
  - LDAP ..... 105
  - LED display
    - direct station selection keys ..... 21
    - function keys ..... 21
  - Line preview ..... 127
  - Line utilization ..... 22
  - Lines
    - hot/warm line ..... 114
  - Lists (for phone numbers and contacts) .... 108
  - Location of the telephone ..... 3
  - Logging on and off as a mobility user .. 139
  - Logging on and off as a mobility user ..... 137
- M**
- Making calls
    - multi-line ..... 110
  - Microphone ..... 46
  - Mobility ..... 136
    - forced logoff ..... 140
    - logon, logoff ..... 137, 139
  - Multi-line
    - accepting calls ..... 109
    - busy override ..... 115
    - LED display ..... 23, 118
  - Multi-line telephone ..... 13
- N**
- Navigator ..... 20
  - Normal dialing ..... 51
- O**
- Open listening ..... 45
  - OpenScape Voice ..... 141
    - abbreviated dialing
      - two-key abbreviated dialing ..... 147
    - accepting anonymous calls ..... 146
    - call tracing ..... 147
    - feature toggle key ..... 141
    - Functions ..... 141
    - list for selective calls ..... 144
    - making anonymous calls ..... 142
    - parallel call ..... 151
    - parking ..... 153
    - reachability ..... 150
    - rejecting anonymous calls ..... 146
    - serial call ..... 150
    - silent monitoring ..... 154
  - OpenScape Voice hunt group ..... 148
  - OpenStage Key Module 40 ..... 17
  - Operating instructions ..... 2
  - Overview tab ..... 120, 123
- P**
- Padlock icon ..... 39
  - Parallel call ..... 151
  - Parking ..... 153
  - Pattern melody ..... 165
  - Pattern sequence ..... 166
  - Phantom line ..... 22
  - Phone number directories ..... 108
  - Phone settings ..... 157
  - Phonebook ..... 32
    - LDAP ..... 33, 105
    - Local phonebook ..... 32
    - New contact ..... 102
  - Picking up the held call ..... 43
  - Pop-up menu ..... 29
  - Primary line ..... 22
  - Privacy ..... 129

Private line .....	22
Program/Service menu .....	37
Programmable sensor keys .....	21

## R

Reachability .....	150
Redial .....	53
Redialing	
multi-line .....	111
Repdial keys .....	92
Resetting sensor keys .....	75
Ringer off .....	129

## S

Search contacts, .....	32
Second call .....	83
ignoring .....	84
rejecting .....	84
Second call with consultation call .....	83
Secondary line .....	22
Security .....	129
Sensor keys	
immediate ring .....	74
Sensortaste .....	68
Serial call .....	150
Set headset port .....	168
Settings .....	157
Shared line .....	22
Silent monitoring .....	154
Single-line telephone .....	13
Speakerphone distance .....	3
Speakerphone mode .....	40, 44
Status icons .....	26

## T

Telephone maintenance .....	181
Telephony interface	
single line .....	29
Time .....	159
Time display format .....	162
Toggle/Connect .....	55
Troubleshooting .....	181
Trunk keys .....	22

## U

User interface .....	14
User support .....	12
Using Ethernet switches .....	16
Using network ports more efficiently .....	16

## W

Warm line .....	52
for lines .....	114
Web interface .....	176, 183

## Communication for the open minded

**Siemens Enterprise Communications**  
[www.siemens.com/open](http://www.siemens.com/open)

Copyright © Siemens Enterprise  
Communications GmbH & Co. KG  
Hofmannstr. 51  
80200 München  
Deutschland

Siemens Enterprise  
Communications GmbH & Co. KG  
is a Trademark Licensee of Siemens AG

Reference No:  
A31003-S2010-U101-29-7619

The information provided in this document contains merely general descriptions or characteristics of performance which in case of actual use do not always apply as described or which may change as a result of further development of the products.

An obligation to provide the respective characteristics shall only exist if expressly agreed in the terms of contract. Availability and technical specifications are subject to change without notice. OpenScape, OpenStage and HiPath are registered trademarks of Siemens Enterprise Communications GmbH & Co. KG. All other company, brand, product and service names are trademarks or registered trademarks of their respective holders.